

Programmable Automatic RCL Meter

PM6304

Users Manual

4822 872 10162

November 1995, Rev. 2, 02/99

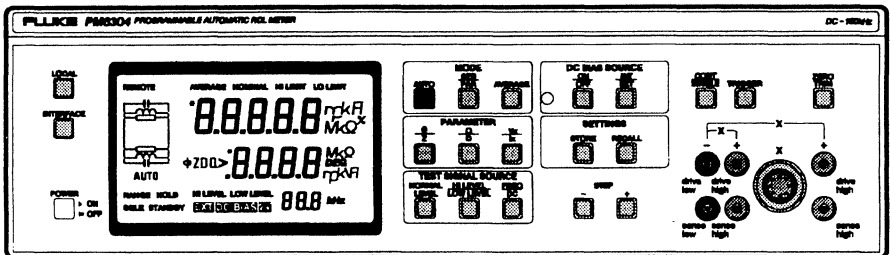

FLUKE®

Please note

In correspondence concerning this instrument, please quote the type number and serial number as given on the type plate.

Bitte beachten

Bei Schriftwechsel über dieses Gerät wird gebeten, die Typennummer und die Gerätenummer anzugeben. Diese befinden sich auf dem Typenschild an der Rückseite des Gerätes.

Noter s.v.p.

Dans votre correspondance et dans vos réclamations se rapportant à cet appareil, veuillez toujours indiquer le numéro de type et le numéro de série qui sont marqués sur la plaquette de caractéristiques.

Important

As the instrument is an electrical apparatus, it may be operated only by trained personnel. Maintenance and repairs may also be carried out only by qualified personnel.

Wichtig

Da das Gerät ein elektrisches Betriebsmittel ist, darf die Bedienung nur durch eingewiesenes Personal erfolgen. Wartung und Reparatur dürfen nur von geschultem, fach- und sachkundigem Personal durchgeführt werden.

Important

Comme l'instrument est un équipement électrique, le service doit être assuré par du personnel qualifié. De même, l'entretien et les réparations sont à confier aux personnes suffisamment qualifiées.

CONTENTS

Users Manual

Instrucciones de instalación y de seguridad

(E)

Istruzioni per la messa in funzione e norme di sicurezza

(I)

Instructies met betrekking tot de installatie en veiligheid

(NL)

Inledande anvisningar och säkerhetsanvisningar

(S)

Figures

Appendix

- **Diagrams and Formulas**
- **Table for Storage Register Contents**
- **Limited Warranty & Limitation of Liability**
- **Declaration of Conformity**
- **Service Centers**

INSIDE THIS MANUAL

This **USERS MANUAL** contains information on all features of the PM6304 and PM6304C instruments.

It starts with a shipment note and an initial inspection.

The manual is organized into the following chapters:

Chapter 1 Installation and Safety Instructions

This chapter should be read before unpacking, installing, and operating the instrument. It describes grounding, power cables, and line voltage settings.

Chapter 2 Main Capabilities

This chapter describes the main features of the instrument, its functions, operation modes, measurement possibilities and its options.

Chapter 3 Getting Started

This chapter starts with general procedures and precautions necessary for operation followed by a short functional test. It contains a description of the display, a summary of controls and connectors on the front and rear panels, and a description of accessories and measurement setups.

Chapter 4 How to Use the Instrument

This chapter provides the user with detailed explanations of the measurement principle and the measurement of different components.

Chapter 5 Function Reference

This chapter contains a description of each function in alphabetical order. Each description includes an explanation of local and remote control functions.

Included in the shipment you find an additional REFERENCE MANUAL.

The REFERENCE MANUAL contains:

- CHARACTERISTICS
- PRINCIPLE OF OPERATION
- BRIEF CHECKING PROCEDURE
- PERFORMANCE TEST
- PREVENTIVE MAINTENANCE
- APPENDIX
- SERVICE CENTERS

CONTENTS

	Page
SHIPMENT NOTE AND INITIAL INSPECTION	
1 INSTALLATION AND SAFETY INSTRUCTIONS	1 – 1
1.1 SAFETY INSTRUCTIONS	1 – 1
1.1.1 Maintenance and Repair	1 – 1
1.1.2 Grounding (Earthing)	1 – 2
1.1.3 Connections	1 – 2
1.1.4 Line Voltage Setting and Fuses	1 – 3
1.2 OPERATING POSITION OF THE INSTRUMENT	1 – 4
1.3 RADIO INTERFERENCE SUPPRESSION	1 – 4
2 MAIN FEATURES	2 – 1
3 GETTING STARTED	3 – 1
3.1 GENERAL INFORMATION	3 – 1
3.2 TURNING THE INSTRUMENT ON	3 – 1
3.3 SELF-TEST ROUTINE	3 – 1
3.4 OPERATION AND APPLICATION	3 – 2
3.4.1 Control Elements, Display and Connections	3 – 2
3.4.2 Measurement Setup and Accessories	3 – 7
3.4.3 Example of a Measurement	3 – 13
4 HOW TO USE THE INSTRUMENT	4 – 1
4.1 THE PRINCIPLE OF MEASUREMENT	4 – 1
4.2 MEASURING COMPONENTS	4 – 8
4.2.1 Test Signal Frequency and Voltage	4 – 8
4.2.2 Resistors	4 – 9
4.2.3 Capacitors	4 – 10
Foil Capacitor	4 – 10
Electrolytic Capacitor	4 – 10
4.2.4 Inductances	4 – 12
4.3 AUTOMATIC ZERO TRIM	4 – 13

4.4	MEASURING MODES	4 – 15
4.4.1	Automatic (AUTO)	4 – 15
4.4.2	Manual	4 – 17
4.4.3	Accuracy	4 – 19
4.5	STORE/RECALL OF INSTRUMENT SETTINGS	4 – 23
4.6	BINNING	4 – 24
4.6.1	Introduction	4 – 24
4.6.2	PM 9559 Bin Programmer (Infrared Remote Control)	4 – 27
4.6.3	PM 9566 Handler Interface	4 – 38
4.7	OUT-OF-RANGE AND ERROR MESSAGES	4 – 40
5	FUNCTION REFERENCE	5 – 1
5.1	FUNCTIONS OF THE FRONT PANEL OF THE INSTRUMENT	5 – 1
5.2	FUNCTIONS OF THE PM 9559 BIN PROGRAMMER	5 – 20

INSTALLATION AND SAFETY INSTRUCTIONS IN FOREIGN LANGUAGES

FIGURES

- Fig. 1 Front view
- Fig. 2 Rear view
- Fig. 3 PM 9540/TWE, SMD Tweezers
- Fig. 4 PM 9540/BAN, 4-wire test cable with banana plugs
- Fig. 5 PM 9541A, 4-wire test cable
- Fig. 6 Single and double test posts
- Fig. 7 PM 9542SMD, SMD Adapter
- Fig. 8 PM 9542A, RCL Adapter
- Fig. 9 PM 9559 Bin Programmer, Infrared remote control

APPENDIX:

- DIAGRAMS AND FORMULAS
- TABLE FOR STORAGE REGISTER CONTENTS
- LIMITED WARRANTY & LIMITATION OF LIABILITY
- DECLARATION OF CONFORMITY
- SERVICE CENTERS

SHIPMENT NOTE

The following parts should be included in the shipment:

- 1 PM6304 / PM6304C Programmable Automatic RCL Meter DC – 100 kHz
- 1 Users Manual
- 1 Reference Manual
- 1 Programmers Manual
- 1 Power Cable
- 2 Fuses
- 2 Single Test Posts

For built-in options, see the type plate on the rear panel:

Type plate

Type number
Code number
Serial number

FLUKE.		
TYPE :	PM6304/xxx	31VA
NC :	9452 063 04xxx	
NO :	LO	50-60Hz

Code number:

9452 X63 04X XX

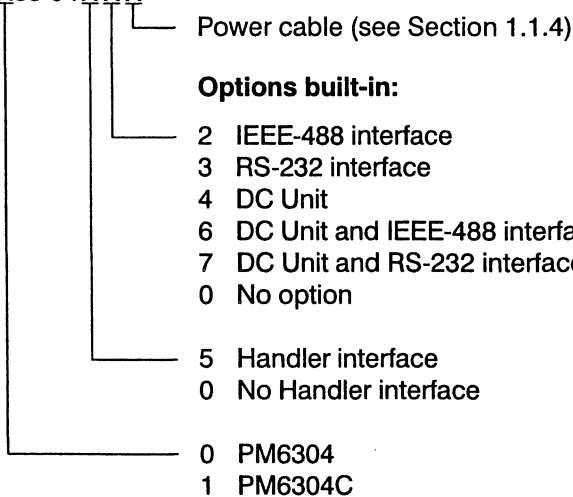

INITIAL INSPECTION

Check that the shipment is complete and note whether any damage has occurred during transport. If the contents are incomplete or there is damage, file a claim with the carrier immediately, and notify the Fluke Sales or Service organization to facilitate the repair or replacement of the instrument. The addresses are listed in the back of this manual.

The performance of the instrument can be tested by using the Performance Test in the Reference Manual.

Chapter **1**

INSTALLATION AND SAFETY INSTRUCTIONS

1 INSTALLATION AND SAFETY INSTRUCTIONS

1.1 SAFETY INSTRUCTIONS

Upon delivery from the factory the instrument complies with the required safety regulations (see Reference Manual, Chapter 1). To maintain this condition and to ensure safe operation, the instructions below must be followed carefully.

1.1.1 Maintenance and Repair

Failure and excessive stress:

If the instrument is suspected of being unsafe, remove it from operation immediately and secure it against any unintended operation. The instrument is considered to be unsafe when any of the following conditions exist:

- It shows physical damage.
- It does not function anymore.
- It is stressed beyond the tolerable limits (e.g., during storage and transportation).

Disassembling the Instrument:

WARNING

Calibration, maintenance, and repair of the instrument must be performed only by trained personnel who are aware of the hazards involved. To avoid electric shock, do not remove the cover unless you are qualified to do so.

Before removing the cover, disconnect the instrument from all power sources. The capacitors in the instrument may remain charged for several seconds after all power has been disconnected.

1.1.2 Grounding (Earthing)

Before any other connection is made the instrument must be connected to a protective earth conductor via the three-wire power cable.

The power plug shall be inserted only into a grounded outlet.

Do not defeat the protective action by using an extension cord without a grounded conductor.

Do not connect a protective ground conductor into the measurement contacts on the front panel, the four contacts of the connector to which the circuit ground is applied, or the external contact of the connector plug.

WARNING

Any interruption of the protective ground conductor inside or outside the instrument or disconnection of the protective ground terminal, is likely to make the instrument dangerous. Intentional interruption is prohibited.

1.1.3 Connections

The circuit ground potential is applied to four of the eight contacts of the front panel connector and is connected to the instrument case via parallel-connected capacitors and a resistor. The external contact of the connector is connected to the instrument case. This avoids ac ground loops while providing good RF grounding.

If the circuit ground potential in a measurement setup is different from the protective ground potential, make sure that the four contacts of the front panel connector are not live.

1.1.4 Line Voltage Setting and Fuses

Before plugging in the line cable, make sure that the instrument is set to the correct line voltage.

WARNING

To avoid injury or death, changing fuses and modifying line cables to local power must be done by qualified service personnel who are aware of the hazards involved.

On delivery from the factory, the instrument is set to one of the following line voltages:

Type	Code No.	Line Voltage	Delivered Power Cable
PM6304 or PM6304C	9452 x63 04xx1	220 V	Universal Europe
PM6304 or PM6304C	9452 x63 04xx3	120 V	North America
PM6304 or PM6304C	9452 x63 04xx4	240 V	England (U.K.)
PM6304 or PM6304C	9452 x63 04xx5	220 V	Switzerland
PM6304 or PM6304C	9452 x63 04xx8	240 V	Australia

The line voltage setting and the corresponding fuse specification are indicated on the rear panel.

Make sure that replacement fuses are of the type and current rating specified. The use of repaired fuses and/or the short-circuiting of fuse holders are prohibited. Do not defeat this important safety feature.

The instrument can be set to the following line voltages: 100 V, 120 V, 220 V and 240 V ac. These nominal voltages can be selected by means of the voltage selector, located on the rear panel, next to the line voltage connector. The fuse is located in a holder at the same place. For line voltage selection or replacement of the fuse, remove the line cable and pry open the compartment with a small screwdriver (see illustration).

Turn the selector to select the appropriate voltage range. If necessary, insert the specified fuse (T0.2A or T0.4A according to IEC127 or T0.25A or T0.5A according to CSA/UL198G) that matches the line voltage setting into the fuse holder.

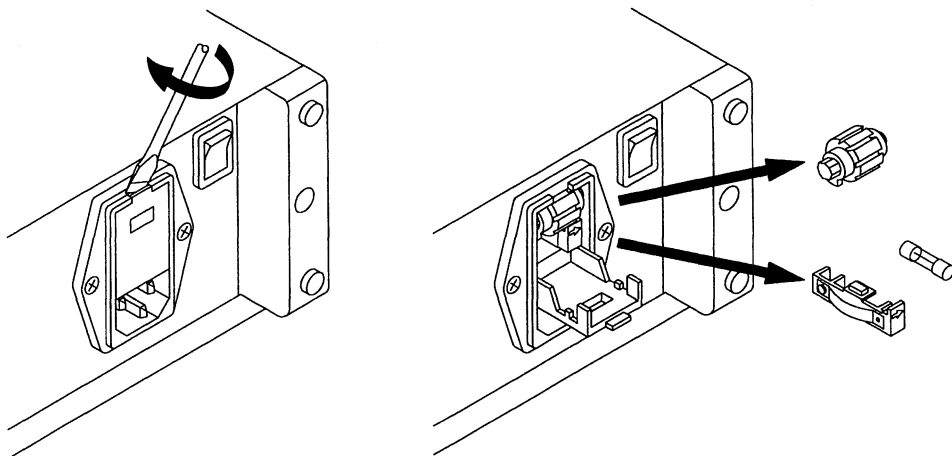

1.2 OPERATING POSITION OF THE INSTRUMENT

The instrument can be operated on a horizontal surface in a flat position or with the tilt bale extended. Ensure that the ventilation holes are free of obstruction. Do not position the instrument in direct sunlight or on any surface that produces or radiates heat.

1.3 RADIO INTERFERENCE SUPPRESSION

Radio interference of the instrument is suppressed and checked carefully. If radio frequency interferences occurs in connection with deficiant suppressed other instruments, further suppression actions may be required.

Chapter **2**

MAIN FEATURES

2 MAIN FEATURES

The **PM6304 Programmable Automatic RCL Meter** is used for precise measurements of resistance, capacitance, and inductance. Its basic accuracy is 0.1 %. The **PM6304C Programmable Automatic RCL Meter** has a higher accuracy of 0.05 % at test signal frequencies up to 2 kHz. The instrument provides an auto-function and autoranging feature. It allows fast and high precision measurements and diagnostic of passive components over a wide range.

The component to be measured is connected to the instrument via front panel posts, the PM 9541A four-wire test cable, or the PM 9542A four-terminal test adapter. The Adapter PM 9542SMD or the PM 9540/TWE SMD Tweezers for surface-mounted components are also available.

Measurements are performed using a four-wire system.

The test frequency is selectable in the range from 50 Hz to 100 kHz.

Three test voltages are available: 2 V, 1 V, and 50 mV rms.

The measurement result, the numerical value, dimension, and the equivalent circuit symbol, are all displayed on the large five-digit liquid-crystal display (LCD), which is updated at a rate of approximately two measurements per second.

A microprocessor controls the measurement process, computes the measurement value, and transfers the result to the display.

In the AUTO mode the dominant and the secondary parameter, either R, C, or L of the component under test is automatically selected for display.

For example, for an inductance with a quality factor Q between 1 and 1000, the instrument indicates the measurement value of the series inductance and the series resistance and as the equivalent-circuit symbol, the series connection of an inductance and a resistance.

In addition to AUTO mode, the following modes can be selected:

- series respectively parallel components
- impedance Z
- phase angle Φ
- quality factor Q, dissipation factor D
- component voltage V_x , component current I_x

An internal DC BIAS voltage (2 V dc) can be added to the measurement voltage for electrolytic capacitors.

An external DC BIAS voltage can also be selected, up to 40 V dc.

DC resistance measurements without an ac test signal can be made by using the optional PM 9565 DC Unit.

The instrument can be programmed and can transfer its measurement data via the optional PM 9548 Interface for IEEE-488, or via the PM 9549 Interface for RS-232. Ten measurements per second are also possible. The RS-232 Interface also allows output of measurement results directly to a printer with no controller needed.

For sorting and binning of components, the optional infrared remote control, the PM 9559 Bin Programmer, and the PM 9566 Handler Interface are available.

Nine complete instrument settings can be stored and recalled for fast and convenient setup.

Chapter **3**

GETTING STARTED

3 GETTING STARTED

3.1 GENERAL INFORMATION

This section outlines the procedure and precautions necessary for operation. It identifies and briefly describes the functions of the front and rear panel controls and the display.

3.2 TURNING THE INSTRUMENT ON

After the instrument has been connected to the line voltage in accordance with Section 1.1.4, it can be turned on by setting the **POWER** switch on the front panel to **ON**.

The specifications given in the Reference Manual, Chapter 1, are valid when the instrument is installed in accordance with the instructions in Chapter 1 of this manual and a warm-up period of 5 minutes is allowed.

After turning the power off, wait at least 5 seconds before turning it on again. This allows all power to completely discharge and the instrument to reset.

3.3 SELF-TEST ROUTINE

After power on, the instrument performs a self-test of the PROM, processor RAM, and external RAM. After this, the software version is indicated in the upper line of the display for approximately 1 second. All segments of the display field are shown for approximately 2 seconds, and the instrument automatically recalls its instrument state before power off.

If a fault is found during self-test, this fault is indicated as follows,

for example: 

For detailed information see Section 4.7.

3.4 OPERATION AND APPLICATION

3.4.1 Control Elements, Display and Connections

3.4.1.1 Front Panel

Keyboard:

Description	Function
-------------	----------



Key used to switch from remote control to keyboard operation.



Key used to display and to select

- Instrument address for remote control via IEEE-488 interface
- Setup for remote control via RS-232 interface.

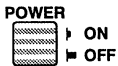

Power switch

Keys used to select the required measurement function

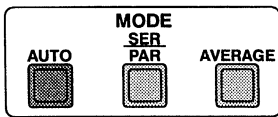

AUTO

- Automatic measurement mode: the dominant and secondary parameters are automatically determined

SER PAR

- Select series or parallel mode

AVERAGE

- Alteration of averaging function to reduce fluctuation of measured value

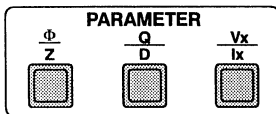

$\frac{\Phi}{Z}$

- Phase angle or impedance (complex impedance)

$\frac{Q}{D}$

- Quality factor ($\tan \phi$; $Q = 1/D$)
Dissipation factor ($\tan \delta$; $D = 1/Q$)

$\frac{V_x}{I_x}$

- Test voltage or current at the component terminals.

Description

Function

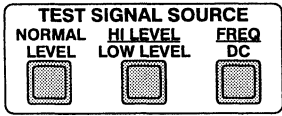

- NORMAL LEVEL**
- Measurement source voltage
 - **NORMAL:** 1 V ac rms or 1 V dc
- HI LEVEL LOW LEVEL**
- **HI LEVEL:** 2 V ac rms or 2 V dc
 - **LOW LEVEL:** 50 mV ac rms or 300 mV dc
- FREQ DC**
- Test signal frequency 50 Hz to 100 kHz or dc (optional)

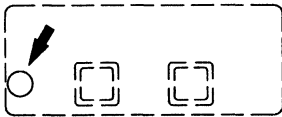

Infrared receiver for PM 9559 Bin Programmer.

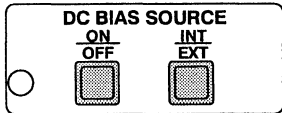

Internal 2 V dc bias on or off or external bias voltage (maximum 40 V dc), e.g., to measure electrolytic capacitors.

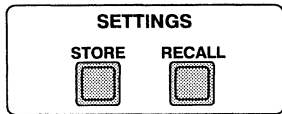

Keys used to store or to recall instrument settings (9 registers).

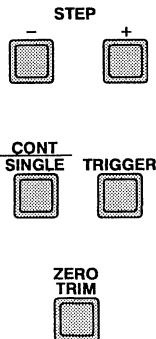

Keys used to step the test signal frequency up or down and to select the storage registers.

Keys used to

- select single or continuous measurement **CONT SINGLE**
- trigger a single measurement (**TRIGGER**).

Key used for automatic trimming of

- open-circuit impedance (> 100 kΩ)
- short-circuit impedance (< 10 Ω).

Display:

Description

Function

REMOTE AVERAGE NOMINAL HI LIMIT LO LIMIT

REMOTE Instrument in remote control via RS-232 or IEEE-488 Interface.

AVERAGE Increased time factor for averaging to reduce fluctuation of measured value.

NOMINAL } Tolerance limits
HI LIMIT } and value using the
LO LIMIT } PM 9559 Bin Programmer.

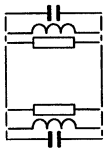

Equivalent circuit symbols:

In AUTO mode the dominant parameter is shown in the upper section; the secondary parameter is shown in the lower section.

* 8.8.8.8.8

Maximum of five digits for the measured value of the dominant parameter.

The asterisk indicates that the component is outside the basic accuracy range of the instrument.

nF, pF, μF, mF
μH, mH, H, kH
MΩ, kΩ, Ω
 %

Units for:

nF, pF, μF, mF for capacitances
μH, mH, H, kH for inductances
MΩ, kΩ, Ω for resistances
 % for tolerance limits in binning mode

Φ Z D Q

Display of selected parameter:

Φ Phase angle
 Z Impedance
 D Dissipation factor
 Q Quality factor

Description

Function

*.8.8.8.8

Maximum of four digits for the measured value of the selected parameter or of the series/parallel parameter in **AUTO** mode. The asterisk indicates during impedance measurements (**Z**) that the component is outside the basic accuracy range of the instrument.

MkΩ
DEG
μFkV

Units for:

- MΩ, kΩ, Ω** for resistances
- DEG** (Degree) for phase angle
- nF, pF, μF, mF** for capacitances
- μH, mH, H, kH** for inductances
- V, mV** for voltage
- mA, μA** for current

AUTO

AUTO mode enabled:
Automatic selection of dominant and series/parallel parameter.

RANGE HOLD HI LEVEL LOW LEVEL
SGLE STANDBY **EXT DC BIAS 2V**

RANGE HOLD Fixes the current internal measuring range (via remote control only).

**HI LEVEL
LOW LEVEL** Test signal voltage

SGLE STANDBY Ready for single measurement (normal level is not displayed).

EXT DC BIAS External bias voltage enabled.

DC BIAS 2V Internal 2 V bias enabled.

88.8 kHz

Test signal frequency in Hz or kHz for ac or dc (**dc**).

Description

Function

Connector on the front panel:

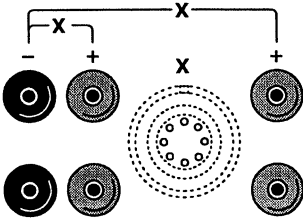

Connectors for

- Test posts for four-wire measurement.
- PM 9542SMD, SMD Adapter

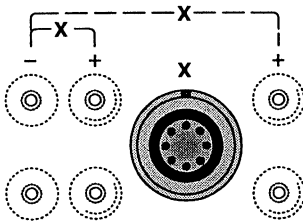

Connector for

- PM 9541A 4-wire test cable with Kelvin Clips
- PM 9542A RCL Adapter
- PM 9540/TWE, SMD Tweezers
- PM 9540/BAN, 4-wire test cable with banana plugs

3.4.1.2 Rear Panel

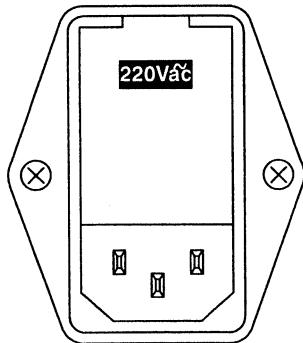

Input power module with fuse and voltage selector.

~ ac (alternating current).

For details, see Section 1.1.4:

Line Voltage Setting and Fuses.

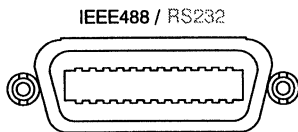

IEEE-488 bus connector for remote control.

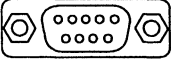
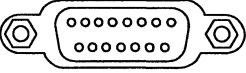
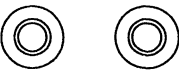
Description	Function
<p>IEEE485 / RS232</p> 	RS-232 connector.
<p>HANDLER INTERFACE</p> 	Component handler interface connector.
<p>EXT DC BIAS</p>  <p>MAX 40V</p>	External dc bias voltage input (maximum 40 V dc).

3.4.2 Measurement Setup and Accessories

For best accuracy, you should perform **ZERO TRIM** (see Section 4.3) when you change the measurement setup, the test signal frequency, or the test signal voltage when test signal frequency is ≥ 10 kHz.

You should not change the setup after trimming if you use test signal frequencies ≥ 10 kHz with the PM 9541A Test Cable with Kelvin Clips, the PM 9542A RCL Adapter, the PM 9540/TWE SMD Tweezers, or the PM 9540/BAN Test Cable.

Test posts

Most common components can be measured with the supplied test posts plugged into the front panel connectors.

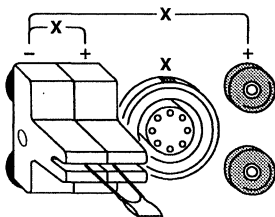

Radial-lead Component

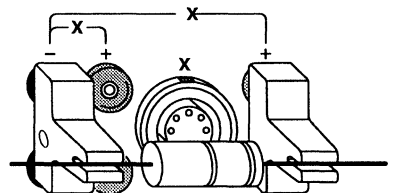

Axial-lead Component

PM 9541A Test Cable with Kelvin Clips

Use the test cable to measure in-circuit components or components of large size.

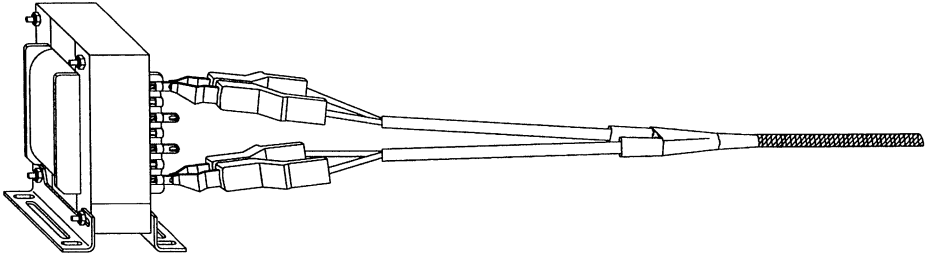

The test cable is connected to the instrument via the round plug (red markings face to face). The plug locks automatically. To unlock the plug, pull on the ridged part.

PM 9542A RCL Adapter

The RCL adapter allows you to make component measurements away from the front panel of the instrument. The RCL adapter can also handle larger components than the front panel connector can.

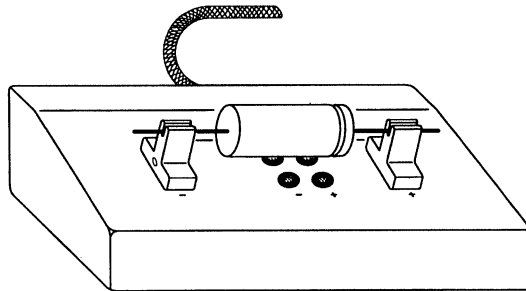

The RCL adapter is connected to the instrument via the round plug on the front panel (red markings face to face).

The supplied single test posts and the double test post can also be directly inserted into the front panel connector of the instrument.

Note: For accurate measurements you should insert only the test posts, cable, or adapter, that you need for the actual measurement.

SMD Adapter PM 9542SMD

The SMD adapter can be used to measure SMD components with a length of 2 to 10 mm, depth > 1 mm, height > 0.5 mm, or a diameter > 1 mm.

For easy and quick insertion and removal of components, insert the SMD adapter into the PM 9542 RCL adapter.

You can also insert the SMD adapter directly into the front panel connector of the instrument. To ease insertion of components, set the instrument in a sloping position (handle folded down)

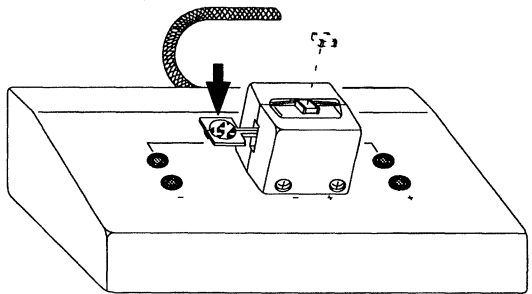
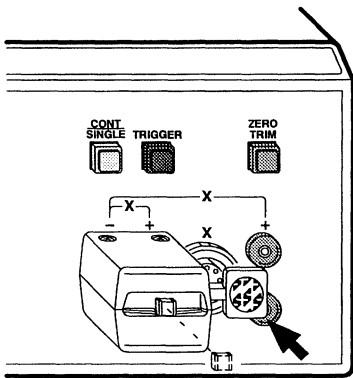

When you use the SMD adapter to measure very small capacitances especially below 100 pF, you must take into account the alteration of the stray fixture capacitances, depending on the separation of the contacts.

Fixture Capacitance (pF)

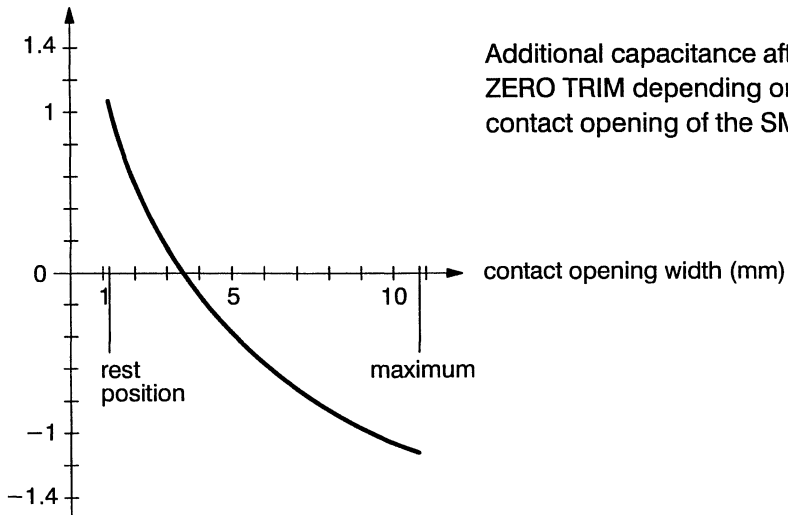

PM 9540/TWE SMD Tweezers

Use the SMD Tweezers to measure single SMD components or in-circuit SMD components.

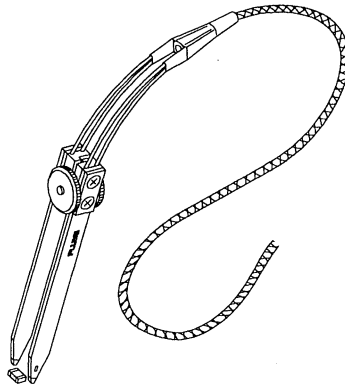

The SMD Tweezers are connected to the instrument via the round plug on the front panel (red marking face to face).

For open-circuit trimming when you are measuring small capacitances, set the opening of the tweezers to the size of the component.

The two-wire measuring technique and the pressure applied by the tips of the tweezers can cause a measuring error in addition to the basic error of the RCL Meter, due to the additional serial resistance (typical 0.02Ω). The presence of dirt or contaminants on the tips of the tweezers can also affect measurements. The tips may be periodically cleaned with alcohol and a non-abrasive cloth.

PM 9540/BAN Test Cable with Banana Plugs

Use the test cable if you need banana plugs for your own special applications.

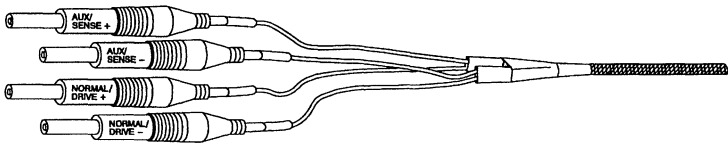

The test cable is connected to the instrument via the round plug on the front panel (red marking face to face).

When you perform ZERO TRIM short-circuit DRIVE+ with SENSE+ and DRIVE- with SENSE- for the open-circuit trimming. Short-circuit all four plugs for the short-circuit trimming.

Two-Wire Measurements

You can measure components with two test leads in two-wire mode by using the plus and minus connectors. For this, it is necessary to short-circuit the drive and sense lines at the instrument. To reduce stray capacitances and interferences, use short leads.

You also can use the eight-pole round connector.

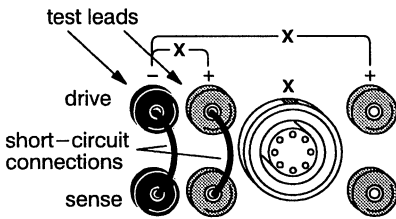

or

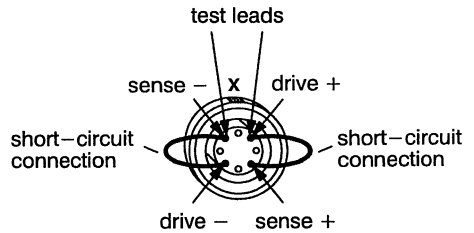

The technical specifications given in Chapter 1 of the REFERENCE MANUAL are valid for four-wire measurements. Four-wire measurements are particularly important for high impedance components at high test signal frequencies and for low impedance components.

3.4.3 Example of a Measurement

WARNING

Before turning the instrument on, ensure that it has been installed in accordance with the instruction in Chapter 1.

Immediately after power on a self-test routine is performed. Then the instrument automatically recalls measurement settings prior to the last power off. (see Section 3.3).

Insert the test posts supplied into the connector on the front panel (Logos face to face).

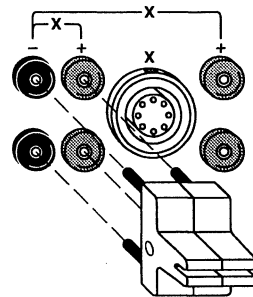

If the display shows *dc*,
press the **FREQ**
DC key.



Select an appropriate measurement
frequency, for example, 1 kHz.

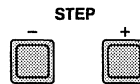

Press the green **AUTO** key.



The display shows:

AUTO

Press the **ZERO TRIM** key for 2 seconds.



For open-circuit trimming
the display shows:

bu5y
Oct

For short-circuit trimming short circuit
the test posts with a short wire or
similar object and press the ZERO TRIM key;
the display shows:

bu5y
5ct

If the ZERO TRIM operation is
unsuccessful, the display shows:
Refer to Section 4.7.

FAIL

If the ZERO TRIM operation was
successful, the display shows:

PASS

Insert a known component
into the test posts,
e.g., a 1 kΩ resistor.

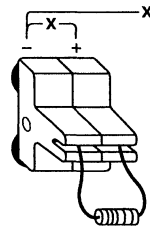

The display shows:

The test is finished.
See Chapter 4 for detailed
information about measurement
of components and
measurement principles.

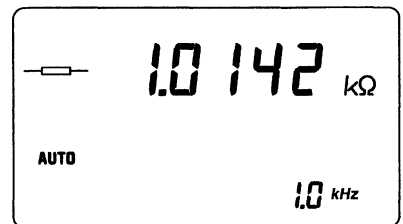

Chapter **4**

HOW TO USE THE INSTRUMENT

4 HOW TO USE THE INSTRUMENT

4.1 THE PRINCIPLE OF MEASUREMENT

The component measurement is based on the current and voltage technique. The component voltage and the component current are measured and converted into binary values. From these values the CPU calculates the electrical parameters of the component. According to the front panel parameter selection different parameters are displayed. Via AUTO mode or by pressing the SER/PAR key when AUTO mode was selected, the dominant and secondary parameters (resistance, capacitance, or inductance) are displayed. In addition manually selected parameter can be displayed (Q, D, Z, Φ , V_x , or I_x).

Each measurement cycle lasts approximately 0.5 seconds. For AC measurements one cycle consists of seven single measurements, the results of which are stored and arithmetically evaluated. Finally the result is transferred to the display. The seven single measurements are as follows:

1. Voltage Measurement: 0°
and internal gain factor setting
2. Voltage Measurement: 90°
3. Reference Measurement: 0°

Gain factor > 1

4. Reference Measurement: 90°
5. Current Measurement: 0°
6. Current Measurement: 90°
7. Reference Measurement: 0°

Gain factor = 1

- Current Measurement: 0°
- Current Measurement: 90°
- Reference Measurement: 0°
- Reference Measurement: 90°

The seven measured values are stored at the end of the single measurements. The microprocessor uses the measured values to calculate the equivalent series resistance R_s , the equivalent series reactance X_s , and the quality factor $Q = X_s/R_s$ of the component. In AUTO mode the microprocessor determines the dominant and secondary parameter, calculates its value, and displays it together with the equivalent circuit symbol. If one of the other parameters is manually selected, this parameter is calculated and displayed. After that the next measurement cycle starts with the seven single measurements.

The display shows:

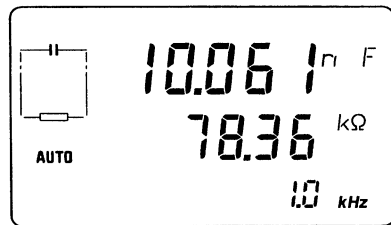

The following phase diagrams and formulas show the mathematic basics for internal calculation of the component value.

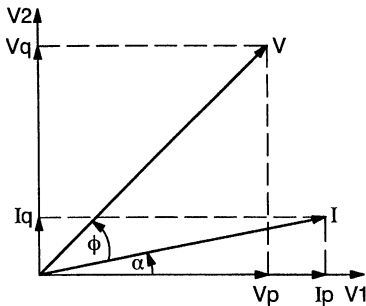

V: voltage
 I: current
 V1, V2: 0°-voltage, 90°-voltage

The phase angle between I and V is ϕ .
 The phase angle between I and V1 is α .

In the diagram the phase relation between I and V happens to be a lossy inductance.

In each measurement cycle, the following components are determined:

Vp, Vq, Ip, Iq.

The series resistance and reactance are calculated from these components.

$$R_s = \frac{V_p I_p + V_q I_q}{I_p^2 + I_q^2} \quad (1)$$

$$X_s = \frac{V_q I_p - V_p I_q}{I_p^2 + I_q^2} \quad (2)$$

The following equivalent circuit is valid:

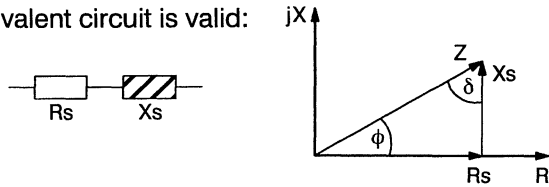

Quality factor: $Q = \tan\phi = 1/D = \frac{|X_s|}{R_s} \quad (3)$

Dissipation factor: $D = \tan\delta = 1/Q = \frac{|R_s|}{X_s} \quad (4)$

The magnitude of Q and the sign of Xs determine which parameter of the component is dominant.

- Xs positive = inductive
- Xs negative = capacitive

The formulas for the various parameters are as follows:

$Q = \frac{|X_s|}{R_s}$ see equation (3)

$Z = \sqrt{R_s^2 + X_s^2}$

$D = \frac{1}{Q}$

$C_p = \frac{1}{\omega(1 + 1/Q^2)|X_s|}$ if $X_s < 0$

$R_p = (1 + Q^2) \times R_s$

$L_p = \frac{(1 + 1/Q^2)|X_s|}{\omega}$ if $X_s > 0$

R_s see equation (1)

$C_s = \frac{1}{\omega|X_s|}$ if $X_s < 0$

$L_s = \frac{|X_s|}{\omega}$ if $X_s > 0$

Impedance $Z = R + jX$

Admittance $Y = 1/Z$

Example:

By using the seven measurements, the instrument has calculated R_s and X_s in accordance with formulas 1 and 2, for example,

$$R_s = 3.068 \text{ k}\Omega$$

$$X_s = -15.199 \text{ k}\Omega$$

From this the instrument calculated:

$$Q = \frac{|X_s|}{R_s} = 4.954$$

The instrument displays the corresponding equivalent circuit symbol with the dominant and the secondary parameter, according to the criteria of the Auto Mode Decision Diagram (see Section 4.4.1); in this case, as X_s is negative and $1 < Q < 1000$:

The display shows:

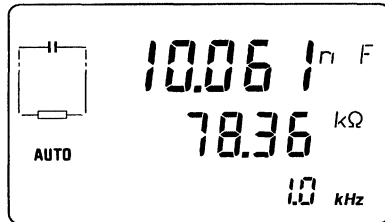

The calculation of the dominant parameter C_p was done according to the following formula:

$$C_p = \frac{1}{\omega(1 + 1/Q^2)|X_s|}$$

$$C_p = \frac{1}{2\pi \times 1 \text{ kHz} (1 + 1/4.954^2) \times 15.199 \text{ k}\Omega} = 10.061 \text{ nF}$$

The maximum display is five digits ± 1 digit tolerance.

Calculation of the other selectable parameters are performed as follows:

$$D = \frac{1}{Q} = \frac{1}{4.954} = 0.202$$

$$R_p = (1 + Q^2) \times R_s = (1 + 4.954^2) \times 3.068 \text{ k}\Omega = 78.36 \text{ k}\Omega$$

$$R_s = 3.068 \text{ k}\Omega \text{ (calculated by the instrument according to formula 1)}$$

$$Z = \sqrt{R_s^2 + X_s^2} = \sqrt{(3.068 \text{ k}\Omega)^2 + (15.199 \text{ k}\Omega)^2} = 15.51 \text{ k}\Omega$$

$$C_s = \frac{1}{\omega |X_s|} = \frac{1}{2\pi \times 1 \text{ kHz} \times 15.199 \text{ k}\Omega} = 10.471 \text{ nF}$$

Φ : The instrument calculates

$$\tan \Phi = \frac{|X_s|}{R_s} = \frac{15.199 \text{ k}\Omega}{3.068 \text{ k}\Omega} = 4.954$$

and gets Φ from an internal tangent table similar to a calculator

$$\Phi = -78.6 \text{ DEG}$$

For accurate measurement, you should select an appropriate test signal frequency; see Section 4.2.

If you measure the same component mentioned in the preceding example, with a test signal frequency that is too low, the resistive part of the capacitive component dominates.

So the instrument determines a resistor as the dominant parameter.

Example: Test signal frequency 100 Hz

The display shows:

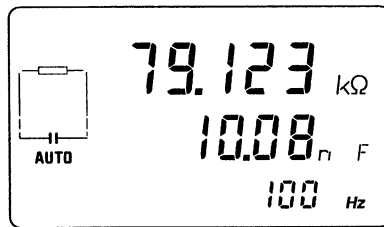

The instrument determined:

$$R_s = 63.248 \text{ k}\Omega$$

$$X_s = -31.680 \text{ k}\Omega$$

and calculated:

$$Q = \frac{|X_s|}{R_s} = 0.501$$

Because $Q < 1$, the display shows a resistor as the dominant parameter.

Calculation of the other parameter is performed by the same formulas:

$$D = \frac{1}{Q} = 2.00$$

$$R_p = (1 + Q^2) \times R_s = 79.123 \text{ k}\Omega$$

$$C_p = \frac{1}{\omega(1 + 1/Q^2)|X_s|} = 10.08 \text{ nF}$$

$$R_s = 63.248 \text{ k}\Omega \text{ (calculated according to formula 1)}$$

$$C_s = \frac{1}{\omega|X_s|} = 50.23 \text{ nF}$$

$$Z = \sqrt{R_s^2 + X_s^2} = 70.74 \text{ k}\Omega$$

$$\tan \Phi = \frac{|X_s|}{R_s} = 0.501$$

$$\Phi = - 26.6 \text{ DEG}$$

If you are interested in mathematics, the appendix of this guide shows the phasor diagrams and formulas for the various components.

4.2 MEASURING COMPONENTS

4.2.1 Test Signal Frequency and Voltage

Resistors, inductors, and capacitors are not ideal electrical components. They all have secondary effects that limit their performance. Understanding the effects is important in understanding the results displayed on the RCL meter. For example, a resistor has shunt capacitance and lead inductance. Inductors have shunt capacitance and resistance in their windings.

The differing reaction of these components, which depends on the frequency and test signal voltage, requires methods of measurement adapted to each situation.

To this end, the PM6304 / PM6304C has a frequency range from 50 Hz to 100 kHz. Resolution: 50, 60, 100, 120, 200, 300, 400 Hz to 19.9 kHz, 20 kHz, 100 kHz

The analog-to-digital converter (ADC), used for digitizing the measured values, is basically insensitive to hum interfered into the measurement setup. Hum interference may degrade measurement accuracy using test frequencies of 60 Hz or 120 Hz at 50 Hz AC power or 50 Hz test frequency at 60 Hz AC power.

The following can be selected as the test signal voltage:

AC voltage:

2 V, 400 Ω internal resistance
 1 V, 100 Ω internal resistance
 50 mV, 100 Ω internal resistance

DC voltage (option):

2 V, 400 Ω internal resistance
 1 V, 100 Ω internal resistance
 300 mV, 100 Ω internal resistance

An internal 2 V dc bias voltage or an external bias of maximum 40 V dc can be added to the AC voltage signal. The external voltage must be free of hums, particularly if test signal frequency is 50 Hz or 60 Hz (line frequencies).

If you measure components with $Z > 10 \text{ k}\Omega$ and if you use an external bias source with an impedance $> 50 \text{ }\Omega$, perform open-circuit trimming with bias voltage applied.

WARNING

A 40 volt external bias can charge a capacitor to a high enough voltage that it can cause injury if it is accidentally discharged. Verify that polarized capacitors are installed with the correct polarity before applying a bias voltage.

4.2.2 Resistors

In principle in addition to its purely resistive component, a resistor has capacitive and inductive components.

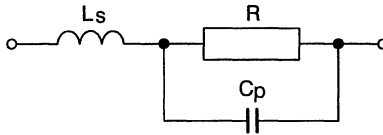

R = DC resistance.

L_s = Inductance of any winding/coiling and of the components leads.

C_p = Shunt capacitance across the resistive component.

In the case of wire-wound resistors, C and L are relatively high due to the winding. In the case of film resistors, these values are considerably smaller.

With low-valued resistors ($<1\text{ k}\Omega$), the series inductive component dominates.



With high-valued resistors ($>1\text{ k}\Omega$), C predominates.

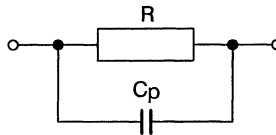

The effect of C and L limits the high frequency performance of the component.

Measurement Conditions:

Select a low test signal frequency, i.e., 1 kHz or measure with DC voltage (option). In the case of resistors in the megohm range, the instrument might recognize the shunt capacitor as the dominant component if the measurement frequency is too high.

4.2.3 Capacitors

Several components, which depend on the type of capacitor, determine the electrical characteristics of a capacitor.

Foil Capacitor:

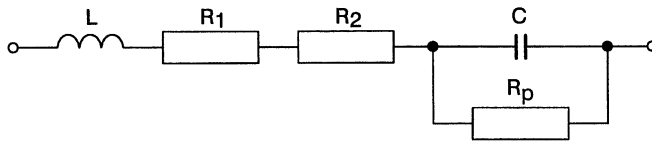

L = Inductance of the lead wires, the bonding and the winding (mainly in the nH area).

R₁ = Resistance of the bonding (5 to 10 ohms in unfavorable cases).

R₂ = Resistance of the foils, which increases as frequency increases.

R_p = Dissipation in dielectric, which can be ignored as frequency increases.

C = Capacitance.

Electrolytic Capacitors:

With AC voltage

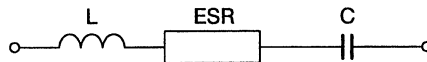

L = Inductance of the connections and of the winding.

ESR = Equivalent series resistance:

Resistance of the electrolytes, the dielectric, DC resistance of the mechanical structure. The ESR depends on the frequency.

C = Overall capacitance.

With DC voltage

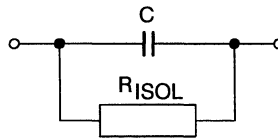

C = Overall capacitance.

R_{ISOL} = Insulating resistance, it determines the leakage current of the component.

Electrolytic capacitors operate at lower frequencies (usually < 10 kHz).

Measurement Conditions:

The frequency for the test signal should not be selected too high as otherwise a capacitance that is too high is measured when the resonant frequency is approached.

$$f_o = \frac{1}{2\pi\sqrt{LC}} \quad f_o = \text{self-resonant frequency}$$

If the frequency is too low, the ohmic and inductive components falsify the result. A test frequency lower than $f_o/30$ should be taken as the approximate value.

For example:

Typical self-resonant frequency for a 100 μ F capacitor is 50 kHz; select test signal frequency less than 1.6 kHz.

Electrolytic capacitors used for smoothing in power supplies should be measured at their operating frequency (100 Hz or 120 Hz).

In order to determine the real dissipation components, a high test frequency is selected for the serial losses and a low one for the parallel losses.

Use DC voltage for measuring the insulating resistance.

4.2.4 Inductances

Coil with iron core

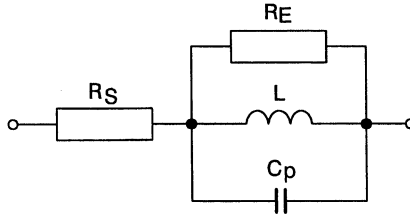

R_S = DC resistance of the copper winding

R_E = Core loss

C_p = Capacitance of the winding

L = Inductance

Measurement Conditions:

As in the case of the capacitor, the test frequency (f_{TEST}) should lie far below the self-resonant frequency (f_0). The f_0 frequency can be very low because of the relatively high capacitance of the winding.

$$f_0 = \frac{1}{2\pi\sqrt{LC}} \quad f_0 = \text{self-resonant frequency}$$

Approximate value: $f_{TEST} = f_0/30$

It is advisable to measure the coil close to its operating frequency if the reaction of the coil under operating conditions is to be determined.

A voltage level that is not too high must be selected for coils because of the saturation effect caused by the iron core. For this purpose, the PM6304 offers a voltage reduced to 50 mV.

Use DC voltage to measure the resistance of the winding.

4.3 AUTOMATIC ZERO TRIM

When pressing the **ZERO TRIM** key for approximately 2 seconds the instrument performs an impedance measurement of the measurement setup and stores the value determined. The display shows **PASS**. For all further measurements this value will be taken into consideration. **To ensure best measuring accuracy you should perform ZERO TRIM when you change the measurement setup, the test signal frequency, or the test signal voltage when the test signal frequency is ≥ 10 kHz.**

If you press the **ZERO TRIM** key with a component connected with an impedance of $<10 \Omega$ or $>100 \text{ k}\Omega$, the value of the component will be taken into consideration. At open or short-circuited contacts of the measurement setup the instrument now indicates a negative resistance value, for instance, or an inductance in case of a connected capacitance (or a capacitor in case of a an inductance.) Please perform ZERO TRIM once again without any component connected in order to obtain correct values.

The TRIM data are stored in a memory and will persist even if the instrument is switched off.

Note: If you use the test cable with PM 9541A Kelvin Clips, the PM 9542A RCL Adapter, or the PM 9540/TWE, SMD Tweezer for test signal frequencies ≥ 10 kHz, you should not change the setup after trimming.

To avoid measurement errors, do not touch the contacts during measuring.

Short-Circuit Trimming

For measuring low impedances, below 100Ω in particular, please short-circuit the contacts of the measurement setup and press the **ZERO TRIM** key for approximately 2 seconds. The display shows **bUSY** and **Sct** (short-circuit). The instrument now performs a measurement and stores the value determined, which is the short circuit impedance. The display shows **PASS**. For all further measurements this value is taken into consideration, including the line and contact impedances. If during short circuit trimming the measured impedance is $>10 \Omega$, **FAIL** will be displayed.

Open-Circuit Trimming

When you measure low capacitances with high test signal frequency the open-circuit impedance of the measurement setup may affect the result. Remove any connected component and press the **ZERO TRIM** key for approximately 2 seconds. The display shows **BUSY** and **Oct** (open-circuit). The instrument performs a measurement considering the value determined, which is the open-circuit impedance, for all following measurements. The display shows **PASS**.

If the impedance measured during open-circuit trimming is $<100\text{ k}\Omega$, the display shows **FAIL**.

For the ZERO TRIM the contacts DRIVE+ and SENSE+ as well as DRIVE- and SENSE- should be connected. As far as the adapters available from Fluke are concerned, this is normally ensured automatically, except for the PM 9540/BAN cable and for the PM 9542SMD SMD Adapter.

If you use the PM 9540/BAN cable in your own special application short-circuit DRIVE+ with SENSE+ and DRIVE- with SENSE- for the open-circuit trimming. Short-circuit all four plugs for the short-circuit trimming.

As far as the SMD Adapter is concerned the contacts are insulated from each other. The contacts are only closed when a component is inserted.

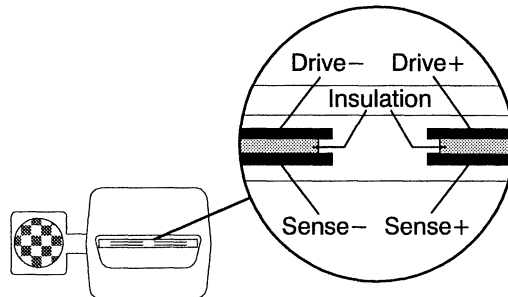

Contacts of the PM 9542SMD, SMD Adapter

To perform ZERO TRIM at an open adapter with the DRIVE/SENSE contacts connected, the SMD Adapter is equipped with SMD components with an impedance of $Z \rightarrow \infty$. Please use this component for open-circuit trimming. For short-circuit trimming you can use one of the attached components with an impedance of $Z \rightarrow 0 \Omega$. These components have a real resistance of typical $4 \text{ m}\Omega$. You should take into account this value if you measure low impedances.

If you need spare sets you can order them via your Service Organization with the following number: 5322 310 32275.

$Z \rightarrow 0 \Omega$

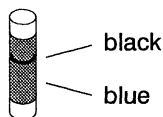

$Z \rightarrow \infty$

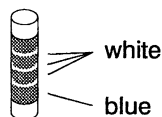

4.4 MEASURING MODES

After power on, the instrument automatically recalls the mode that was set before power off.

- Select a suitable measurement setup.
- Select the matching test signal frequency and voltage (refer to Sections 3.4.2 and 4.2).
- Execute ZERO TRIM if necessary.
- Insert the component.

Galvanic nonconducting components, e.g., electrolytic capacitors, should be measured with the internal bias voltage activated. To do this

- Press the **DC BIAS ON/OFF** key.
- The display shows **DC BIAS 2V**.

4.4.1 Automatic (AUTO)

In most cases, you will be interested in the dominant parameter of the component. This is automatically determined and displayed in the AUTO mode. Press the green **AUTO** key. The display shows **AUTO**, the value of the dominant parameter in the upper line, the value of the secondary parameter in the lower line, and the appropriate equivalent circuit symbol.

Function and Key Operation

Display

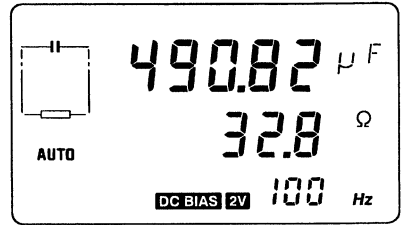

The decision criterion for selecting the dominant parameter is $Q = D = 1$. Refer to Section 4.1. The values Q and D not only depend on the component but also on the test signal frequency used.

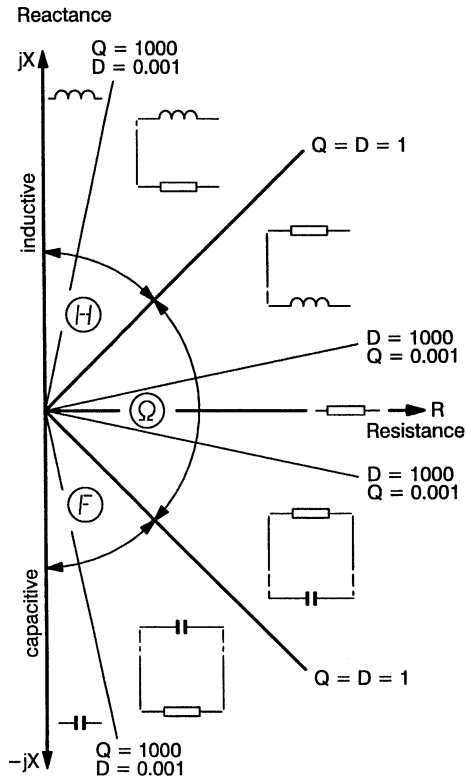

AUTO MODE DECISION DIAGRAM

4.4.2 Manual

If you want to determine a parameter that differs from the one automatically calculated by the instrument, press the appropriate function key:

Function and Key Operation

Display

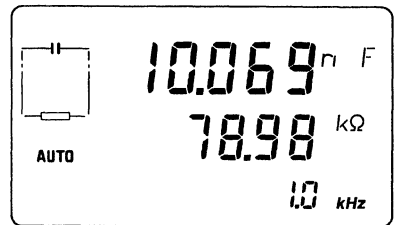

Series or parallel parameter

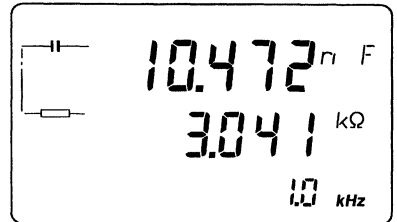

Impedance

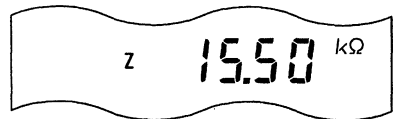

Phase angle

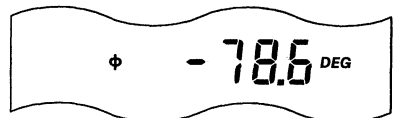

Function and Key Operation

Display

Dissipation factor

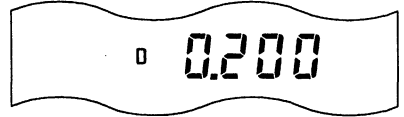

Quality factor

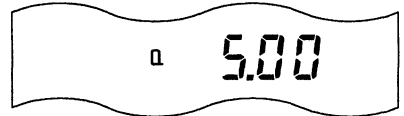

Current measured ★



Voltage measured ★

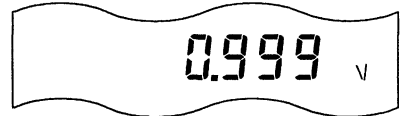

- ★ Current or voltage is displayed for approximately 3 seconds. The instrument then returns automatically to the parameter you selected beforehand.

The values displayed for the selected parameter are calculated by the instrument. They are based on the values measured for the series reactance and the series resistance (refer to Section 4.1).

4.4.3 Accuracy

The following diagrams show the measuring range and accuracy of the instrument as a function of test signal frequency and voltage.

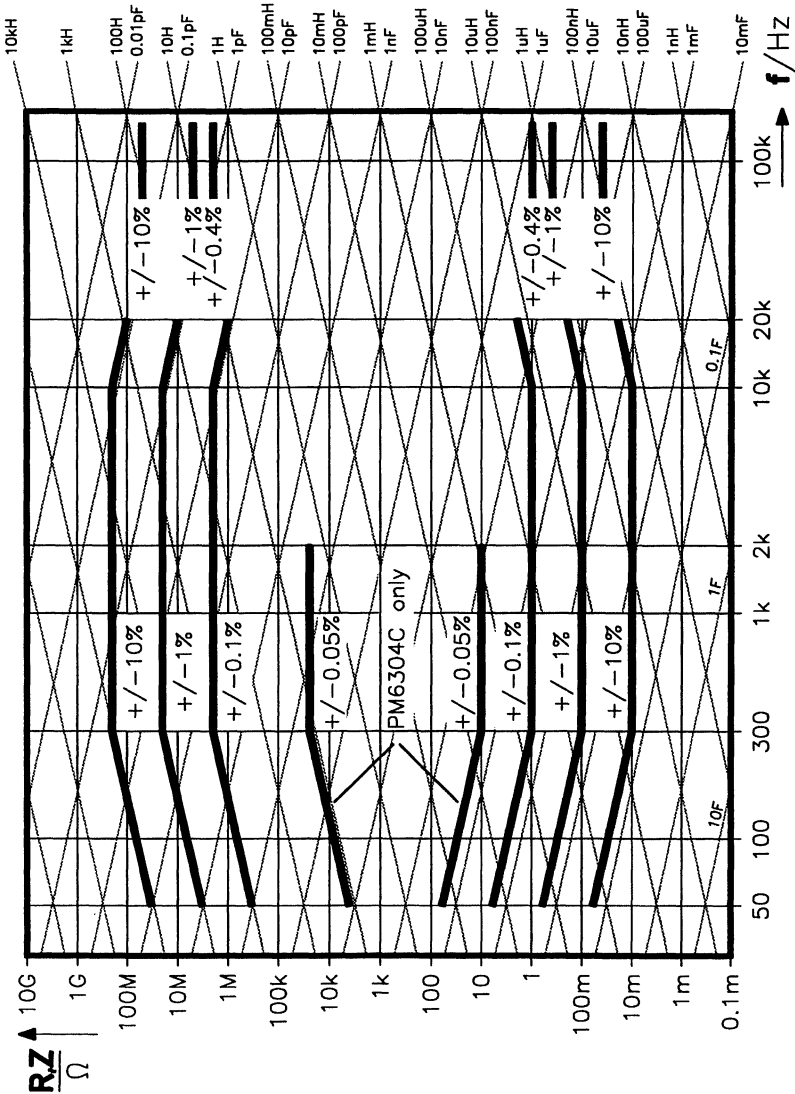

Accuracy with 1 V (NORMAL LEVEL)

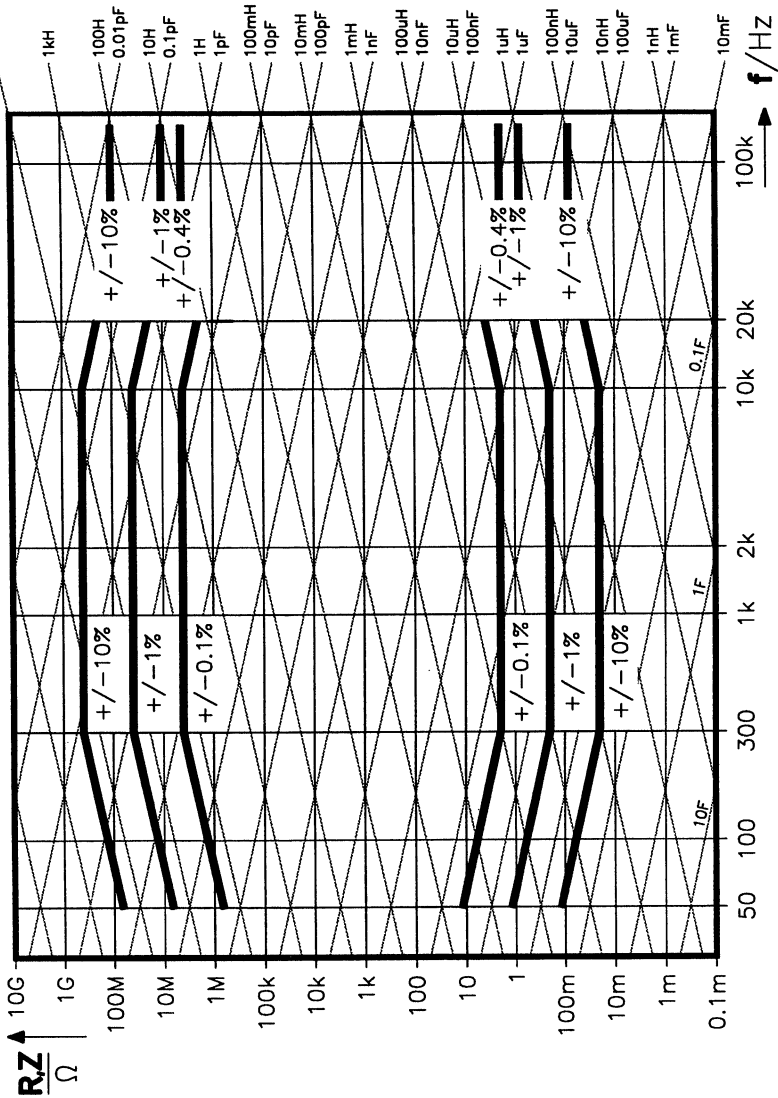

Accuracy with 2 V (HIGH LEVEL)

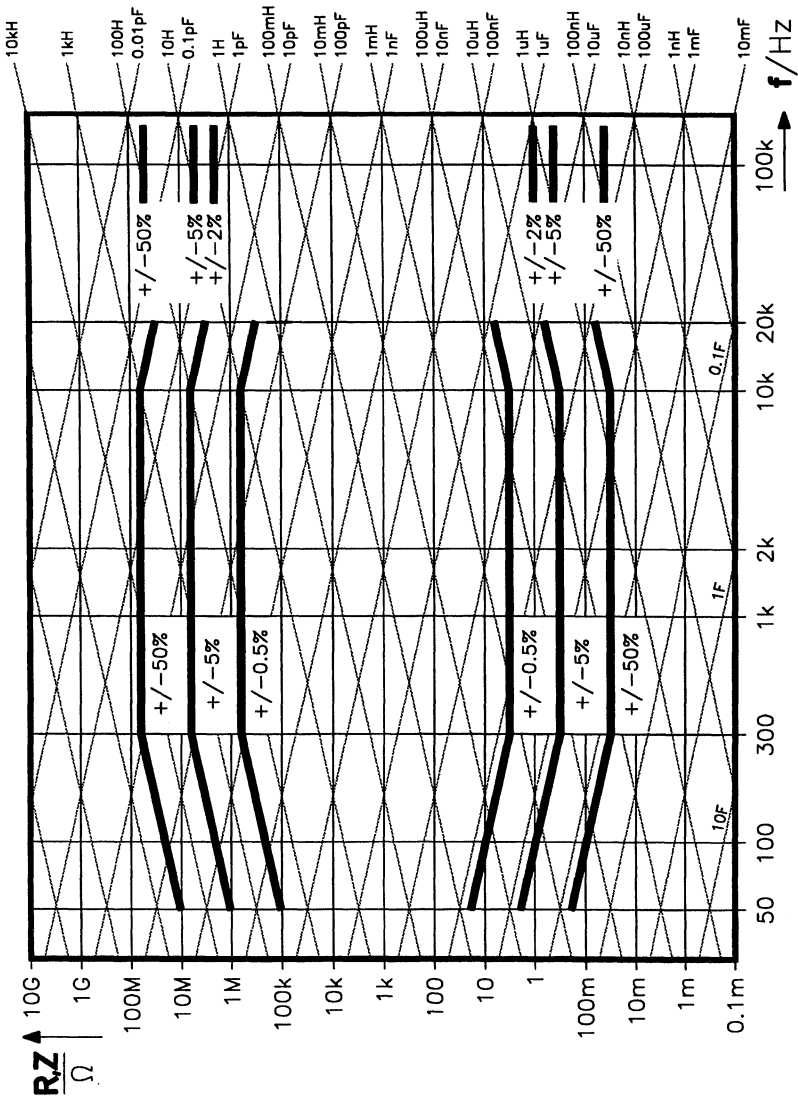

Accuracy with 50 mV (LOW LEVEL)

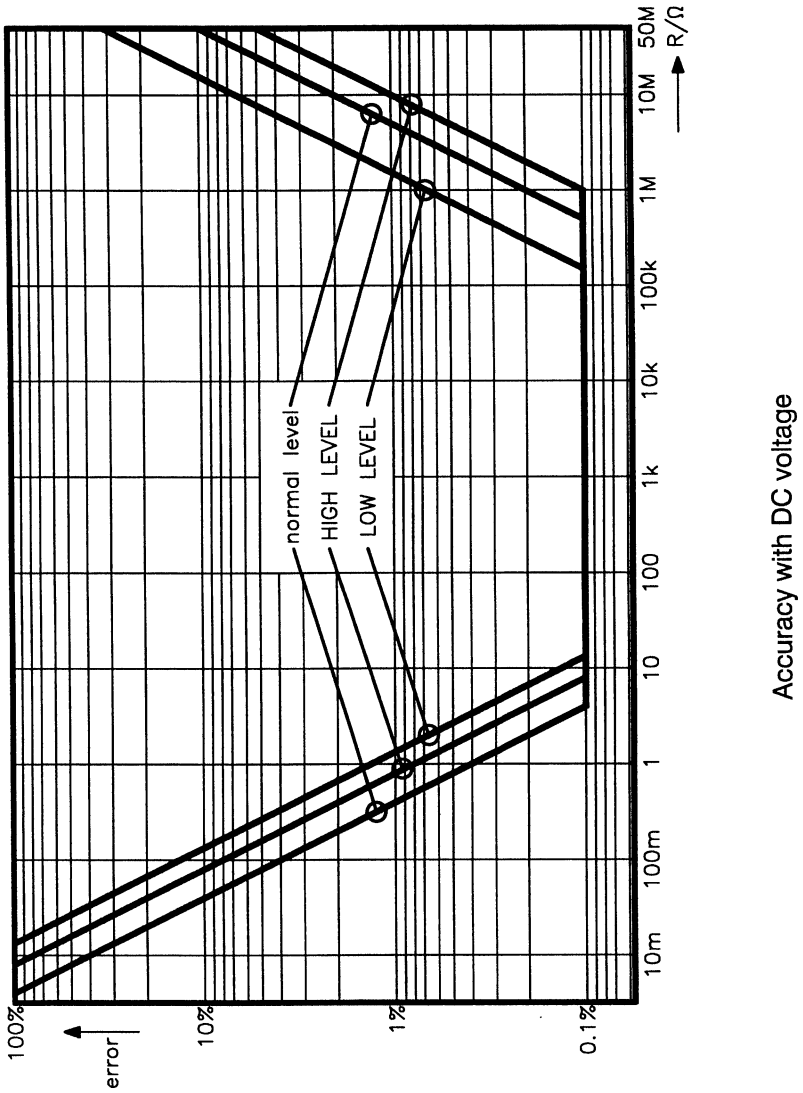

For detailed information see REFERENCE MANUAL, Chapter 1.

4.5 STORE/RECALL OF INSTRUMENT SETTINGS

Nine complete instrument settings including trim data can be stored in memory registers 1 to 9. The current mode is automatically saved separately. The memories are buffered by battery so that the data are retained even after the instrument is turned off.

After power on, the instrument runs through its start routine, and then goes to the mode that was last set.

Store

Data are stored by pressing the STORE key. The display shows **Sto** and a digit from 1 to 9 for the memory register number. This number under which the settings are to be stored can now be selected by using the +/- step keys; the measured values are not stored.

Pressing STORE once again saves the settings under the register number selected. Any values that may exist there already are overwritten and lost in the process.

Recall

Stored settings are called up by pressing the RECALL key. The display shows **rCL** and a memory register number. The display panel starts to flash. The data from this memory register are only displayed but not yet called up.

You can use the +/- step keys to select memory register numbers 1 to 9 to display their contents. When you press the RECALL key again, the stored setting displayed is called up.

4.6 BINNING

4.6.1 Introduction

Binning means sorting components by their measured value into boxes or similar containers.

During the binning process with the PM6304, similar component values are allocated to defined sorting fields known as bins to obtain better tolerances, closer matching or pass/fail sorting.

You can define a maximum of 10 bins. For this purpose, you can use an interface for remote control with a PC (IEEE-488 or RS-232 as an option) or an infrared remote control, the PM 9559 Bin Programmer (option).

The instructions for programming with the PC are described in detail in the PROGRAMMERS MANUAL and in brief form in Chapter 5. This section describes binning using the PM 9559 infrared remote control.

The PM6304 checks the component according to the criteria of bins 1 to 9, last of all according to bin 0, and displays the bin the component is allocated to. If none of these requirements are met, the display shows **FAIL**.

Values and limits (tolerances) for 10 complete bin records, each record for a maximum of ten bins (bins 0 to 9), including the selected instrument settings can be stored in registers of the PM 6304. These registers are independent of those that contain the instrument settings typed in at the front panel.

The limits of the bins can be defined in the following ways according to the various demands:

- Binning components can be defined with a certain value according to different tolerance classes, for example, for quality control or incoming inspection.

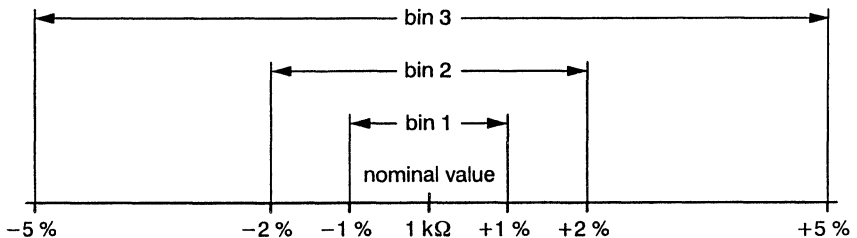

Nested limits with reference to a nominal value.

The instrument checks in the sequence bin 1, bin 2 ... to bin 9 and then bin 0. If the greatest tolerance is programmed for bin 1, then **all components** lying within this tolerance are immediately allocated to bin 1.

A different parameter than that for bin 1 to 9 can be defined for bin 0.

For example, bins 1 to 9 check the tolerance of a capacitor and bin 0 checks at last the quality factor of the capacitor.

The display is as follows:

Component meets tolerance defined in:		Display
bin 1 to 9	bin 0	
YES	YES	bin 1 to 9
NO	do not care	FAIL
YES	NO	bin 0

- Binning components can be defined according to certain values, e.g. resistors according to the series E12, here with $\pm 5\%$.

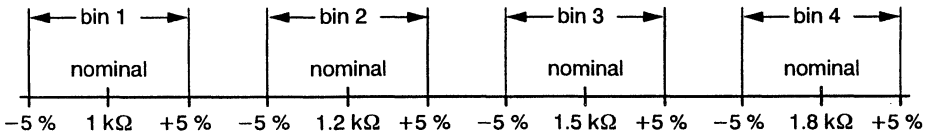

Sequential limits with reference to nominal values.

If limits overlap, a component lying within this overlapping area is always allocated to the bin with the lower number.

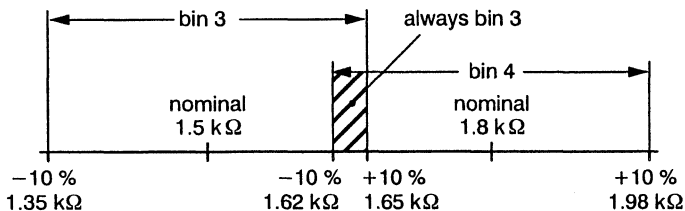

- Nested and sequential limits can be combined.

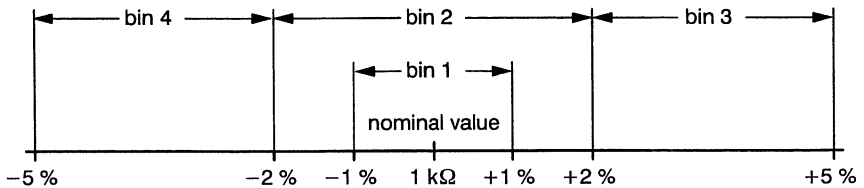

Sequential and nested limits.

The limits can be programmed directly as absolute values instead of a nominal value with an upper and lower limit in percent:

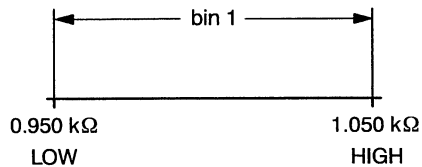

When storing, the instrument checks the values entered for plausibility. A nominal value with an upper limit of +5 % and a lower limit of +5% or a value without limits would not be accepted. The instrument displays **Error** and the number of the bin concerned.

No check is made whether the tolerances selected lie in the accuracy range of the instrument. This accuracy depends on the type and the value of the component to be measured and on the test signal frequency and voltage. Refer to Section 4.4.3.

4.6.2 PM 9559 Bin Programmer (Infrared Remote Control)

4.6.2.1 Keyboard

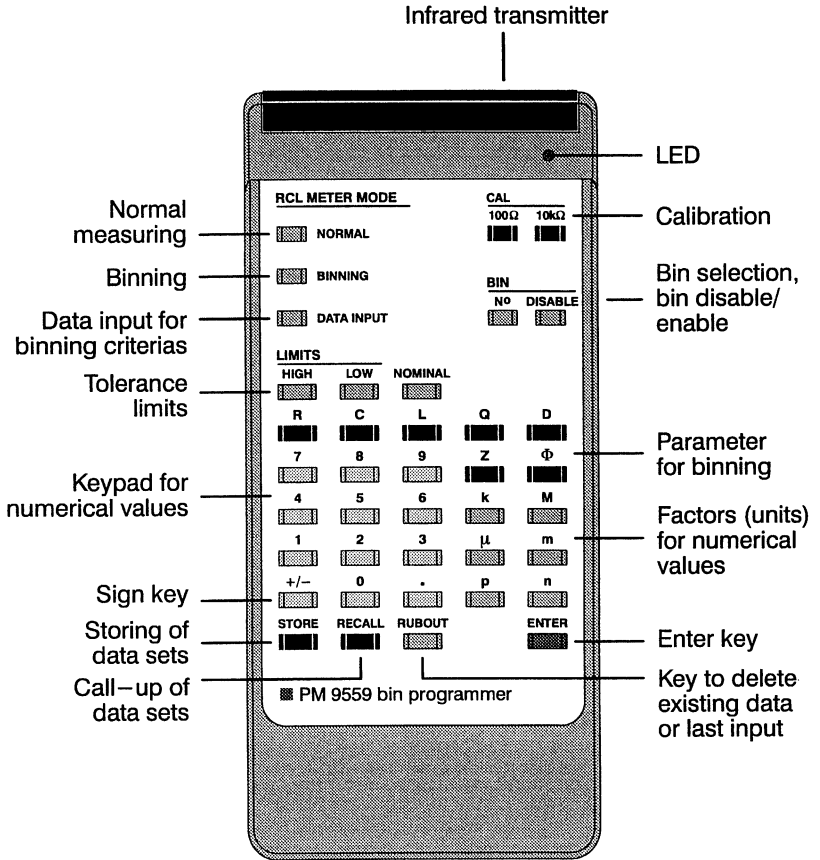

4.6.2.2 Battery Replacement

The remote control is supplied with power by means of the accompanying 9 V block battery.

Inserting the battery:

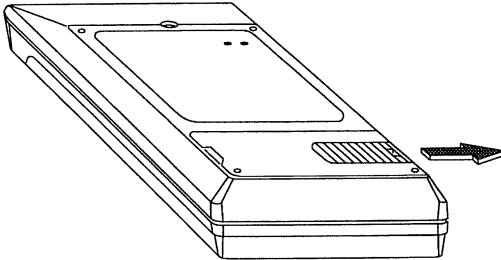

Pry open the battery compartment at the back of the remote control.

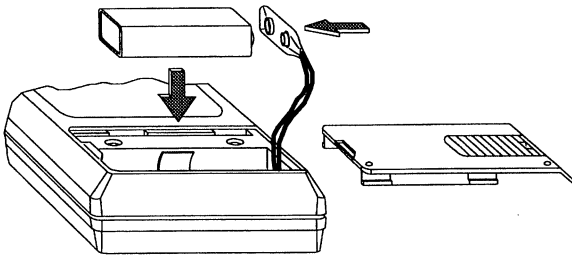

Attach battery terminals and insert the battery. The battery is protected from falling out by a retaining clip. Close the compartment.

Operational check: Press any key; the pilot light must flicker. If necessary, check the battery.

NOTE: Remove dead batteries and dispose of them according to local regulations.

CAUTION: To prevent the remote control from being damaged, use only leak-proof batteries of the type 6F22G or similar for replacement.

4.6.2.3 Programming with the Infrared Remote Control

You can define a set of bins by using the following steps.

The examples are based on empty memory locations. If values are contained there, delete the old values with the **RUBOUT** key before entering new ones.

Pressing the **RUBOUT** and the **ENTER** key after selecting a bin number deletes **all values** of the bin.

Function and Key Operation



Display

Set the instrument to data input.

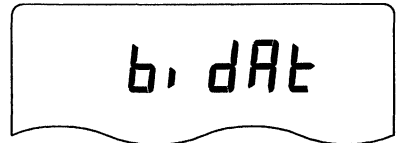
 DATA INPUT



Select the bin.

BIN
No 1
 

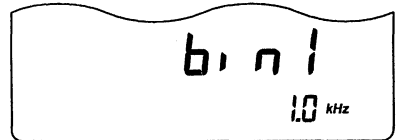

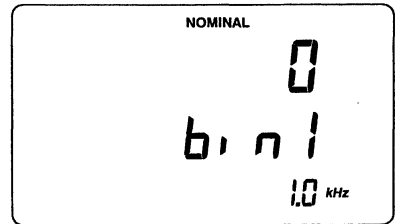

Set to nominal value.

NOMINAL

Define the parameter and set the value.

R 1 **k**
  

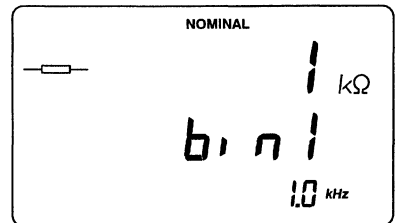

Function and Key Operation

Display

Set the upper limit ★.

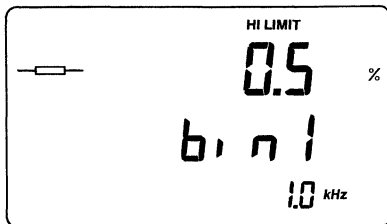

Set the lower limit ★.

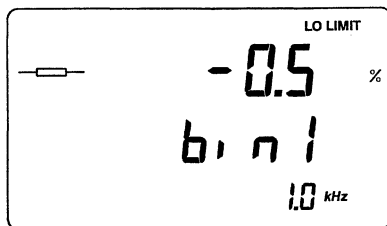

enter

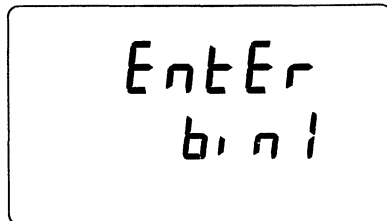

The instrument automatically selects the next bin.

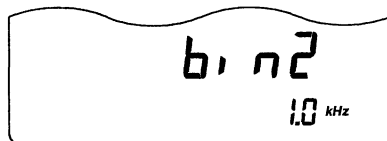

If the nominal values selected for the next bins are to remain the same as in bin 1, then the tolerances for these bins refer to this nominal value.

Function and Key Operation

Display

Set the upper limit ★.

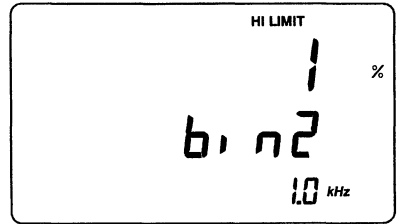

Set the lower limit ★.

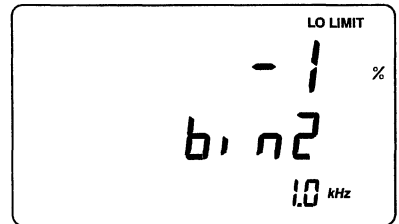
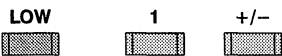

Enter

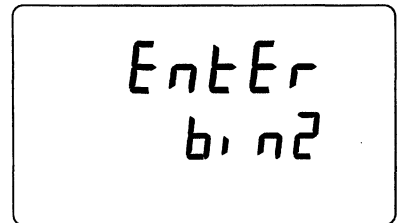

The instrument automatically selects the next bin.

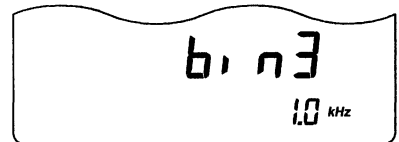

- ★ It is also possible to set only the upper or lower limit. The instrument automatically inserts the same value with the appropriate sign for the other limit. However, if values are already stored here, these remain unchanged.

A maximum of 10 bins can be defined.

This example referred to nested bins with tolerances in percent.
 Other input types, as described in Section 4.6.1, are possible as follows.

Function and Key Operation

Display

Input as an absolute value:





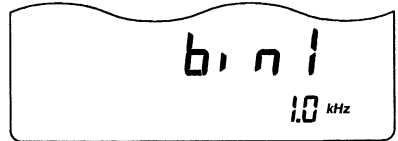

Set the instrument to data input.
 Select the bin.

 DATA INPUT

BIN
NO 1
 







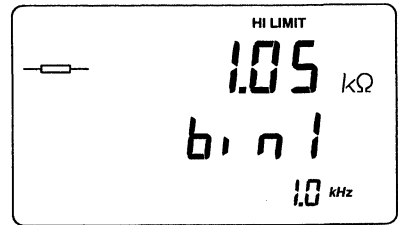

Select the upper limit.
 Define the parameter.
 Set the absolute value.

HIGH **R**
 
 1 . 0 5 k
    



Select the lower limit.
 Define the parameter
 (the same as for the upper limit).
 Set the absolute value.

LOW **R**
 
 . 9 5 k
   

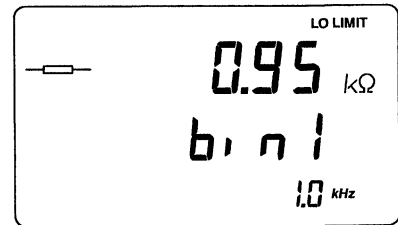

Function and Key Operation

Display

Enter

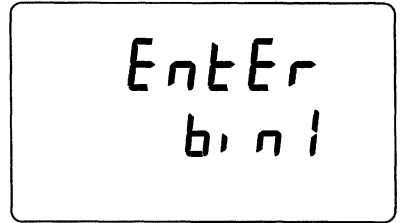

The instrument automatically selects the next bin.

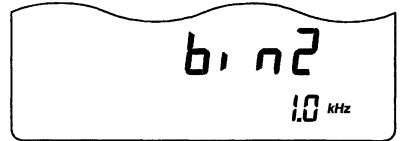

If **Error** appears when pressing the **ENTER** key, please check to see whether the data record contains a nominal value programmed at an earlier stage (**NOMINAL** key).

Note: The data for a bin are stored in a buffer after every acknowledgment (**ENTER**). These data are lost when the instrument is turned off or when leaving bin programming by pressing a front panel key. After the **STORE** function the data are stored in memories buffered by battery (memory locations **0** to **9**).

Function and Key Operation

Display

Store

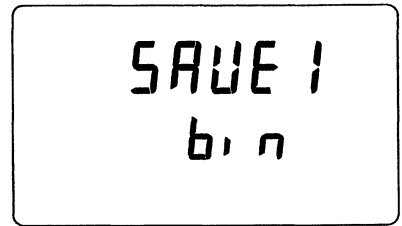

Enter

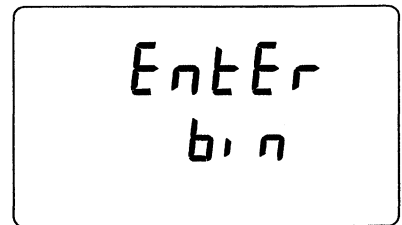

In addition to the data of the bin set, the instrument settings selected, such as test signal frequency and voltage, measuring mode, DC bias etc. are also stored. Any data found in the storage register are overwritten.

Stored sets are called up by pressing the **RECALL** key, the desired storage register number (1 to 9) and the **ENTER** key.

If some programmed bins from a set are not to be taken into account during binning, they can be deactivated by pressing the **DISABLE** key (except for bin 1).

Pressing the **ENTER** key now shows only the active bins. A deactivated bin is activated again by pressing the **BIN N°** key and the relevant number.

A table in the appendix has been provided for your notes on assignment of the storage register contents. You can make a copy of the table and fill in the programmed values.

4.6.2.4 Binning

Select the measurement setup and, if necessary, execute trimming (**ZERO TRIM**).

Press the **DATA INPUT** key on the infrared remote control and call up the bin record desired by pressing **RECALL**. If no data have been stored yet, enter the parameters and tolerances according to which binning is to take place. Refer to Section 4.6.2.3.

Storage Registers

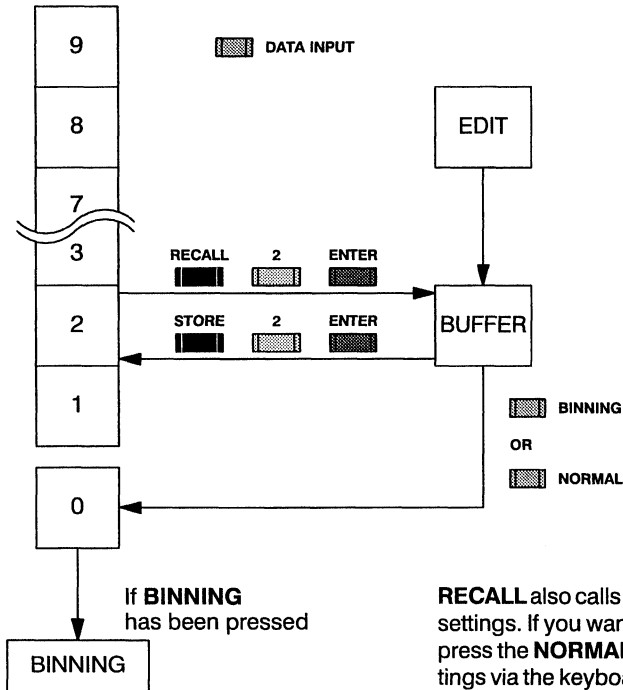

RECALL also calls up stored instrument settings. If you want to alter the settings press the **NORMAL** key, select new settings via the keyboard of the RCL meter, press the **DATA INPUT** key, and press the **BINNING** key to start binning.

The instrument is set to the bin mode by pressing the **BINNING** key. The instrument settings stored in the memory are adopted. The instrument switches automatically to single measurement to avoid measuring errors when inserting or removing the components to be measured.

The display shows maximum five digits. The instrument calculates with a higher resolution. For example, the upper limit for bin 1 is 100 Ω , the instrument measures 100.004 Ω ; in this case the display shows 100.00 Ω , but the component is correctly allocated to bin 2.

Insert the component and start measuring by pressing the **TRIGGER** key. The PM6304 checks the component according to the criteria of the individual bins and shows in what bin the component is and its value. If none of the criteria of bin 1 to 9 are met, the display shows **FAIL**, see table on Page 4 – 25.

Example:

Function and Key Operation

Display

Set the instrument to data input.

 DATA INPUT

b, dAt

Call up the stored data.

RECALL 1
 

LoAd i
 b, n

Function and Key Operation

Display

Enter

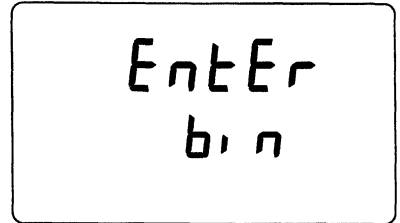

Set the instrument to binning.

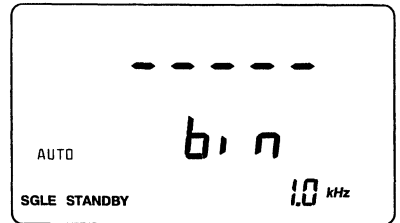

Insert the component.

Start the measurement.

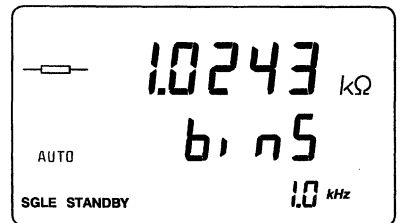

Remove the component and insert the next one.

Start the measurement.

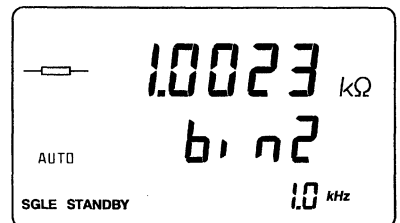

Press the **NORMAL** key to switch back to normal mode.

4.6.3 PM 9566 Handler Interface

To make further handling of the checked components easier, you can connect appropriate control lines to the bin numbers by means of the **HANDLER INTERFACE** (option). For example, LEDs that can identify the bin where the component is placed can be connected by means of these control lines. This process can also be automated by means of the appropriate application (conveyor and electromagnetic flaps).

Identification by LEDs (principle)

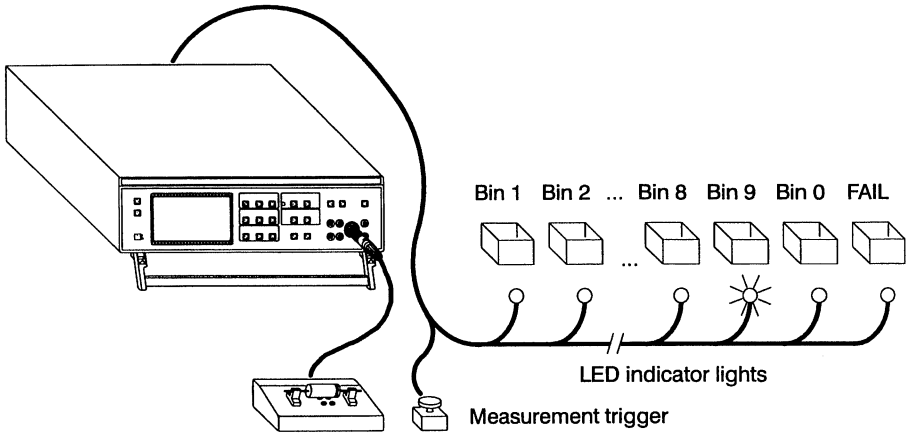

Automatic handling (principle)

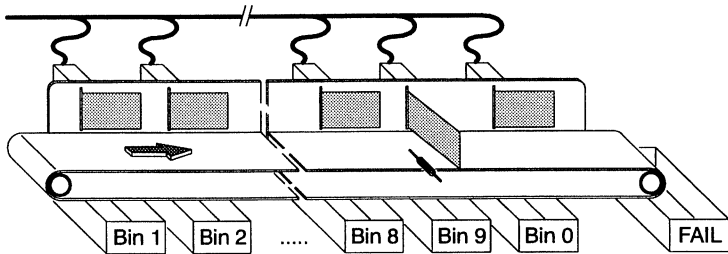

Connection Example:

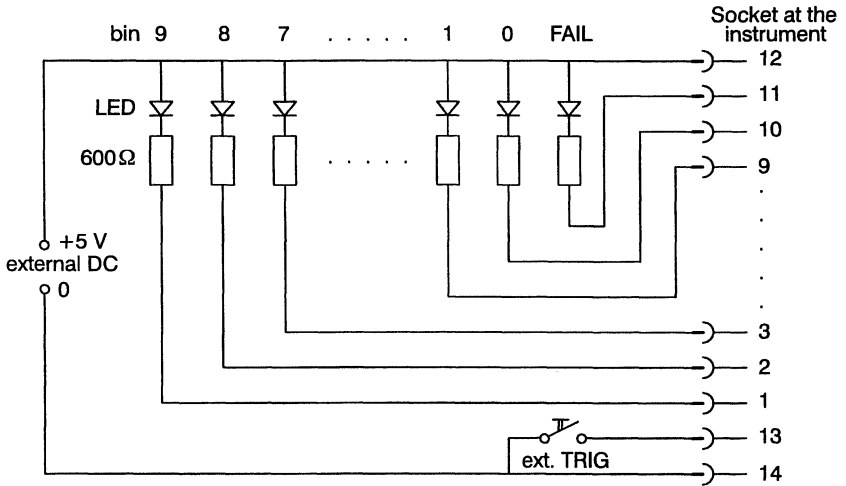

The internal driver stages have open collector outputs.
 External operating voltage max. +24 V DC voltage.
 Maximum collector current 200 mA.

Pin assignment:

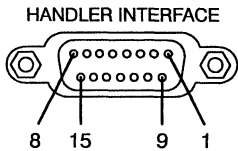

View of the rear

- 1 = Bin 9
- 2 = Bin 8
- 3 = Bin 7
- 4 = Bin 6
- 5 = Bin 5
- 6 = Bin 4
- 7 = Bin 3
- 8 = Bin 2
- 9 = Bin 1
- 10 = Bin 0
- 11 = FAIL
- 12 = + DC
- 13 = TRIGGER
- 14 = Ground
- 15 = Shielding (screen)

4.7 OUT-OF-RANGE AND ERROR MESSAGES

The middle segments of the digits are displayed when the following limits are exceeded:

- Resistance >200 M Ω at AC,
> 50 M Ω at DC
- Capacitance > 32 F at 50 Hz, > 16 mF at 100 kHz
- Inductance >637 kH at 50 Hz, >318 H at 100 kHz

The asterisk in front of the upper digits indicates that the measured component is outside the measurement range of the basic error limit.

Select a different appropriate test signal frequency and check that the measurement is within the basic accuracy; see tables in Section 4.4.3.

The asterisk in front of the lower digits only indicates when impedance is being measured that the value is outside the basic error limit. Other parameter values displayed by this digits are secondary parameters and generally not within the basic accuracy range of 0.1 %; for these no asterisk is displayed.

After power on, the instrument checks the PROM, the processor RAM, and the external RAM. Additionally the instrument generates error messages if there are faults during measurements or trimming or if there is a fault during data transfer to a printer.

Errors are indicated as follows:

- | | |
|--------------|--|
| <i>Err 1</i> | Program memory checksum error |
| <i>Err 2</i> | Processor RAM defective |
| <i>Err 3</i> | External RAM defective |
| <i>Err 4</i> | External RAM, backup (current instrument settings) destroyed |
| <i>Err 5</i> | External RAM, stored instrument settings 1 to 9 destroyed |
| <i>Err 6</i> | Error during analog to digital conversion of the test signal |

<i>Err 7</i>	EEPROM defective
<i>Err 8</i>	Error in trim data (EEPROM)
<i>Err 9</i>	Error in calibration data (EEPROM)
<i>Err 10</i>	Error in binning data (EEPROM)
<i>Err 11</i>	Error during line frequency detection
<i>Err 14</i>	Test signal out of limits during trimming
<i>Err 4B</i>	Communication error to the printer (time-out)

Errors 19 to 41 are errors during recalibration.

A detailed description is given in the Service Manual, Chapter 9.

During measurement with the bias voltage activated, the display shows **oVer** if there is excessive DC current flow from the bias source.

If the values entered for binning do not match each other, the instrument displays **Error** when an attempt is made to store them.

If the instrument cannot compensate the short-circuit or open-circuit impedance during trimming, it displays **FAIL**. Check the contacts and try it again.

Chapter **5**

FUNCTION REFERENCE

5 FUNCTION REFERENCE

In Section 5.1, all functions of the instrument that can be called up at the key panel are described in alphabetical order. Each function description contains:

- A detailed explanation of the function.
- The key sequence for setting or calling up via the keyboard and the relevant display.
- The commands for remote control.

The Programmers Manual contains detailed information about the interfaces for the remote control, the program message syntax, and the complete set of remote control commands.

Some functions are possible only with the appropriate options:

For example, binning components according to tolerance class requires the PM 9559 Bin Programmer or an interface for remote control. Measuring components with DC voltage only requires an integrated DC unit.

These functions are identified in the description by 'option'.

Section 5.2 describes the functions of the PM 9559 Bin Programmer for programming tolerance ranges for binning components.

5.1 FUNCTIONS OF THE FRONT PANEL OF THE INSTRUMENT

AUTO Mode

In this mode, the instrument automatically determines the dominant parameter of the component measured and displays the appropriate equivalent circuit symbol. The value of the dominant component is displayed in the upper line, and the value of the secondary parameter is displayed in the line below.

The decision criterion for defining the dominant component is $Q=D=1$, with Q and D not only dependent on the features of the component but also on the test signal frequency used (see Sections 4.1 and 4.2).

Decision criteria for defining the dominant parameter and for the equivalent circuit symbol in the sectors of the phase level:

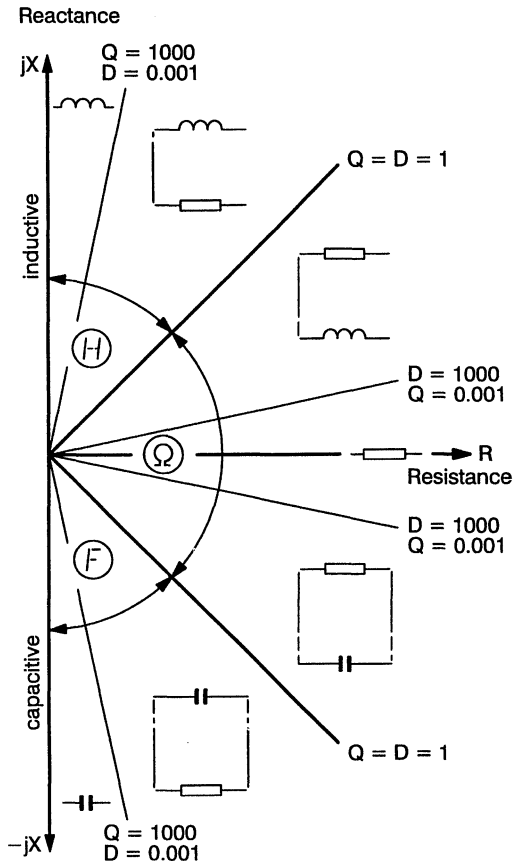

AUTO MODE DECISION DIAGRAM

e.g.

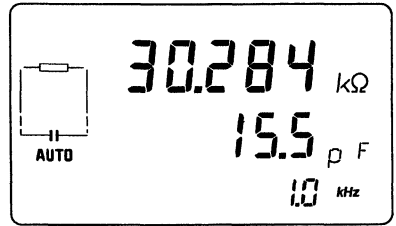

Remote control commands:

Setting: AUTO
 Query for dominant and secondary component: COM?

AVERAGE

With continuous measurement, the instrument performs an exponential average from the individual measurements before the value is shown in the display. The time factor of the average is increased by pressing the **AVERAGE** key. This reduces fluctuations in the display.

The original time factor reappears when the key is pressed again.

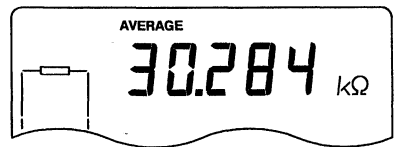

Remote control commands:

Activate: AVG ON
 Deactivate: AVG OFF
 Query: AVG?

CONT/SINGLE

Continuous/Single Measurement

Press this key to select either continuous or single measurements. For single measurement, the instrument is in a standby status. Press the **TRIGGER** key to start the measurement. This function is mainly used for binning in the bin mode. In this way, components can be inserted or removed without the instrument executing a measurement.

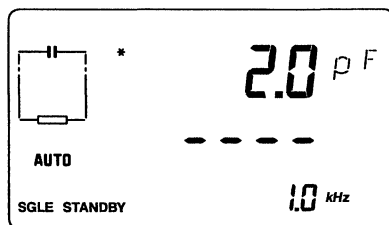

Insert component and take a measurement:

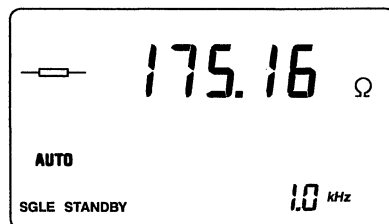
**Remote control commands:**

Setting:

CON or SIN

Start of a single measurement:

TRIG

Query:

TRIG?

D Dissipation Factor

Refer to **Q/D** Quality / Dissipation Factor.

DC DC Voltage Test Signal (Option)

Refer to **FREQ/DC** (Test Signal Frequency).

DC BIAS SOURCE

For measuring electrolytic capacitors a DC voltage should be supplied to the AC test signal. Press the **ON/OFF** key. The **INT/EXT** key is used to select between an external DC voltage (max. 40 V), which is supplied via sockets at the rear of the instrument, or an internal DC voltage of 2 V.

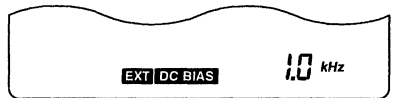

Remote control commands:

Setting:

DC_BIAS INT
 DC_BIAS EXT
 DC_BIAS OFF

Query:

DC_BIAS?

EXT External

Refer to **DC BIAS SOURCE**.

FREQ/DC Test Signal Frequency

Press the **FREQ/DC** key longer than 1 second to change from an AC voltage signal to a DC voltage signal (option).

Press the key briefly (less than 1 second) to changes the frequency step by step: 100 Hz, 1 kHz, 10 kHz, 100 kHz, 100 Hz, 1 kHz, 10 kHz, 100 kHz ...



>1 Sec



<1 sec



Remote control commands:

Selecting the test signal: TEST_SIG AC or TEST_SIG DC
 Setting the AC frequency: FRE x

x = Frequencies possible:
 50 Hz, 60 Hz, 100 Hz, 120 Hz, 300 Hz, 400 Hz to 20 kHz, 100 kHz

Queries: TEST_SIG?
 FRE?

HI LEVEL/LOW LEVEL Voltage of the Test Signal

Key used to select a voltage for the test signal higher or lower than 1 V:

HI LEVEL: 2 V AC voltage or DC voltage;
 400 Ω internal resistance

LOW LEVEL: 50 mV AC voltage, 300 mV for DC voltage;
 100 Ω internal resistance

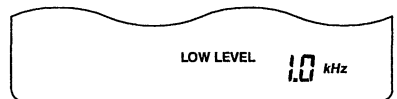
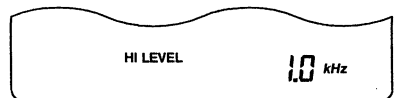

Remote control commands:

Setting: LEV LO or LEV HI or
 LEV NO (normal)

Query: LEV?

INTERFACE (Option)

Depending on the internal interface, the instrument address (IEEE-488 Interface) is displayed when you press the **INTERFACE** key. Press the **STEP** keys to select a different address. With a built-in RS-232 interface, the display shows **Co** or **Pr** (Communication Mode or Printer Mode) and then the current configuration. Press the **INTERFACE** key again to step through a menu to select mode of transmission, baud rate, data bits, parity, and handshake. If more than 3 seconds passes and no key has been pressed, the instrument returns to normal display; altered settings are not stored. To store the settings, press the **INTERFACE** key several times until the normal display appears.

INTERFACE

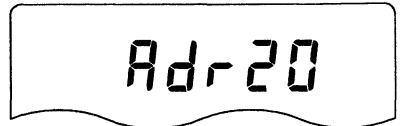
**Display with IEEE-488:**

Address 20

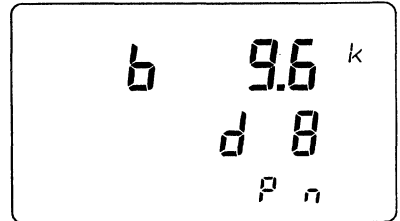
Display with RS-232:

Baud rate 9600, data bits 8,
parity none.

The Programmers Manual contains a detailed description about the configuration setting.

INT/EXT

Internal/External

 Refer to **DC BIAS SOURCE**.

I_x Current Measured

Refer to **V_x/I_x** (Voltage/Current).

LEVEL Test Signal Voltage

Refer to **HI LEVEL/LOW LEVEL**.

LOCAL

Press this key to switch back from remote control to keyboard operation. You can lock the key with a remote control command to prevent inadvertent or unauthorized use.

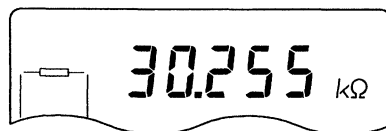
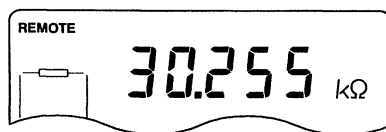

Remote control commands:

No device-specific message

Common commands, e.g., with the PM 2201 Interface:

Reset to local:

IOLOCAL

Lock key:

IOLOCKOUT

LOW LEVEL Lower Voltage for Test Signal

Refer to **HI LEVEL/LOW LEVEL**.

MODE of Measurement

Refer to **AUTO, SER/PAR, AVERAGE**.

NORMAL LEVEL Test Signal Voltage

Press this key to return to a test signal voltage of 1 V with an internal resistance of 100 Ω , if HI LEVEL or LOW LEVEL was selected.

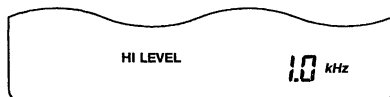

Remote control commands:

Setting: LEV NO

Query: LEV?

PAR Parallel Parameter

Refer to **SER/PAR**.

PARAMETER

Refer to Φ/Z , Q/D , V_x/I_x .

Q/D Quality/Dissipation Factor

Press this key to display the quality factor Q or the dissipation factor D calculated by the instrument for the component up to 1000 or 0.001.

Q and D not only depend on the features of the component but also on the test signal frequency used. Refer to Chapter 4 and to the appendix at the end of these operating instructions.

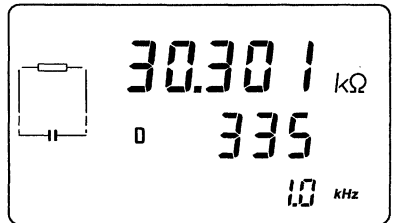
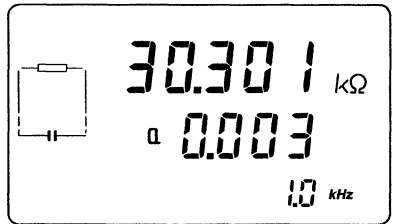

Remote control commands:

Setting:

PARAM QUA or PARAM DISS

Query for setting:

PARAM?

Query for value:

QUAL? or DISS?

RECALL

Press the **RECALL** key. The display shows *rCL*, the present storage register number and the stored instrument settings. Press the **STEP** keys to select registers 1 to 9. Press the **RECALL** key again to load the settings displayed including trim data.

RECALL

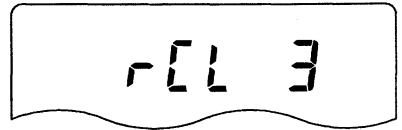

STEP

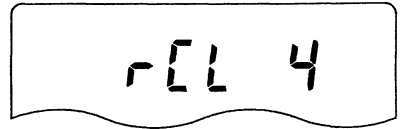

e.g.

RECALL

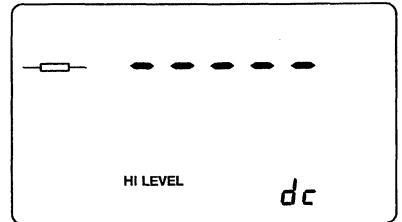

Remote control commands:

*RCL x

x = Storage registers 1 to 9

SER/PAR Series or Parallel Parameter

In the **AUTO** mode when the instrument has determined a resistance as the dominant parameter with a shunt capacitance and when it displays the relevant equivalent circuit symbol, you can display the calculated series resistance and capacitance of the component by pressing the **SER/PAR** key; the sign **AUTO** is switched off. Press the key once again to display the shunt parallel parameters again.

This function applies to all components whose equivalent circuit symbols are shown under the keyword for **AUTO** mode.

The instrument uses the phase diagrams and formulas listed in the appendix of these users manual as the basis for the calculations.

e.g.

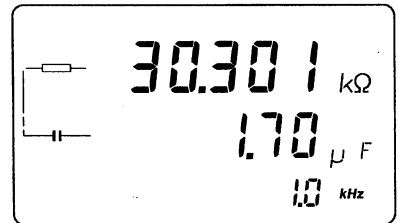
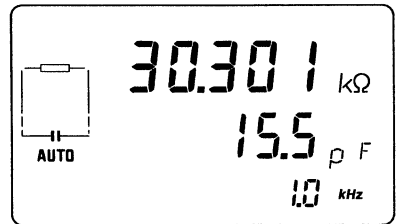

Remote control commands:

Setting:

SER or PARAL

Query for value
of the serial/parallel
parameter:

CAP? or RESI? or INDU?

SINGLE Single Measurement

Refer to **CONT/SINGLE**.

STEP +/- Step Keys

These keys have two functions:

1. If **STORE** or **RECALL** was pressed beforehand, these keys are used to select storage registers 1 to 9 for storing or calling up instrument settings.

STORE



Sto 3

STEP



Sto 4

2. If no key was pressed beforehand, these keys change the frequency of the test signal step by step:

50 Hz, 60 Hz, 100 Hz, 120 Hz, 300 Hz, 400 Hz to 20 kHz, 100 kHz

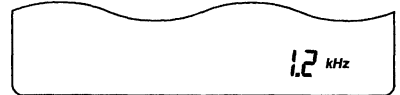
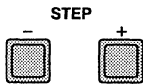
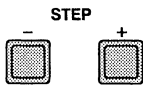

Remote control commands:

None

STORE

You can store nine different instrument settings including trim data of the measurement setup. The settings are retained even after power off of the instrument.

Select the mode desired and press the **STORE** key. The display shows **Sto** with the present storage register number. Press the **STEP** keys to select a location between 1 and 9. Press the **STORE** key again to save the instrument settings (not the measuring results). The last setting prior to power-off of the instrument is automatically stored in register 0.

To recall the settings, refer to **RECALL**.

STORE

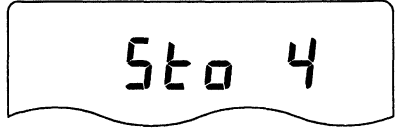

STEP



STORE

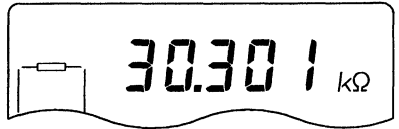

Remote control commands:

*SAV x

x = Storage register 1 to 9

TEST SIGNAL SOURCE

Refer to **NORMAL LEVEL, HI LEVEL/LOW LEVEL, FREQ/DC.**

TRIGGER Starting a Single Measurement

Refer to **CONT/SINGLE** (continuous/single measurement).

V_x/I_x Voltage/Current

Press this key to display the voltage V_x or current I_x measured at the component. After approximately 3 seconds, the display jumps back to the parameter selected beforehand (not in remote control operation).

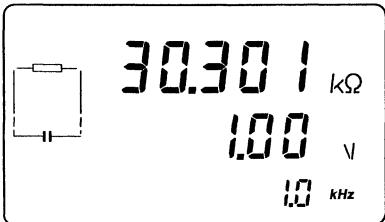
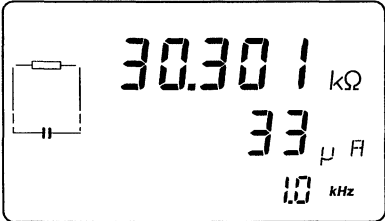

Remote control commands:

- Setting: PARAM VOL or PARAM CUR
- Query for setting: PARAM?
- Query for value: VOL? or CUR?

Z Impedance

Refer to Φ/Z at the end of the list.

ZERO TRIM Open-circuit Trimming / Short-circuit Trimming

When you are measuring components of low impedance, line and contact impedances can falsify the measuring result. When you are measuring high impedances, this can also be the case due to the parallel impedance of the measurement setup.

When you press the **ZERO TRIM** key for 2 seconds when there is a short-circuit input, the line and contact impedances are determined and considered for the subsequent measurements.

When you press the **ZERO TRIM** key for 2 seconds when there is an open input, the impedance of the measurement setup is determined and considered for the subsequent measurements.

The display shows **bUSY** and **Sct** respectively **bUSY** and **Oct** during trimming. After trimming it shows **PASS**. If the display shows **FAIL**, the short-circuit impedance is too high ($>10 \Omega$) to be trimmed by the instrument or the open-circuit impedance is $<100 \text{ k}\Omega$.



with open
input

A rectangular display box containing the text "bUSY" on the top line and "Oct" on the bottom line, both in a digital font.

A rectangular display box containing the text "PASS" in a digital font.

Remote control commands:

TRIM

Φ/Z Phase Angle Phi / Impedance

Press this key to display the impedance of the component. Press it again to display the phase angle between the current and the voltage measured at the component.

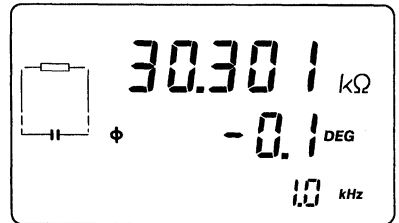
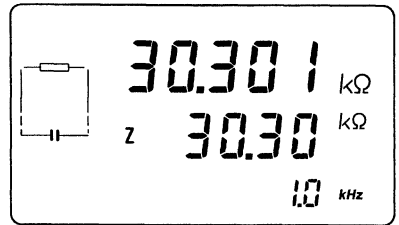

Remote control commands:

Setting:

PARAM IMP or PARAM PHA

Query for setting:

PARAM?

Query for value:

IMP? or PHA?



5.2 FUNCTIONS OF THE PM 9559 BIN PROGRAMMER (OPTION)

BIN

Press the **DATA INPUT** key to set the bin to data input, then press the **N^o** key to call up the desired bin. Next press a digit **0** to **9** to check the data in the bin or to enter a new data.

Press the **DISABLE** key to deactivate the bin displayed (bin 1 cannot be disabled). In this case, the data are not taken into account during binning, but are retained in the memory. Press the **N^o** and **0** to **9** keys to reactivate disabled bins.

 DATA INPUT

BIN
N^o 1
 

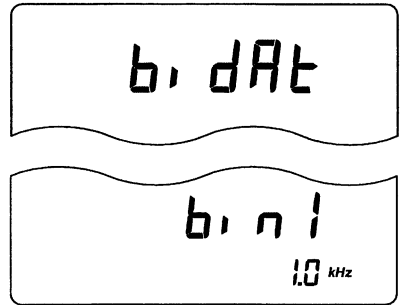

The bins can be defined as follows to meet different requirements.

- Nested limits can be set with reference to a nominal value \star to bin components according to tolerance classes:

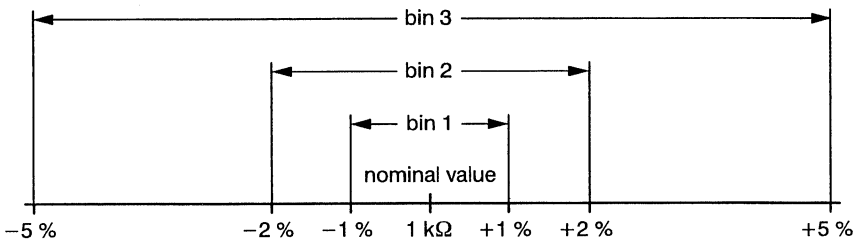

Bear in mind that the instrument checks the criteria of the bins in the sequence 1 to 9, ending with bin 0. If bin 1 contains the largest tolerance ($\pm 5\%$), then each component with a tolerance $< 5\%$ is immediately allocated to bin 1.

For example, bins 1 to 9 check the tolerance of a capacitor and bin 0 checks the quality factor of the capacitor.

The display is as follows:

Component meets tolerance defined in:		Display
bin 1 to 9	bin 0	
YES	YES	bin 1 to 9
NO	do not care	FAIL
YES	NO	bin 0

- Sequential limits can be set with reference to a nominal value \star to bin components according to values.

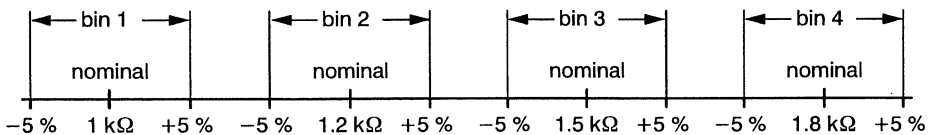

Ensure that the limits do not overlap. If a component lies within an overlapping area, it is always allocated to the bin with the lower number.

- Combined nested and sequential limits

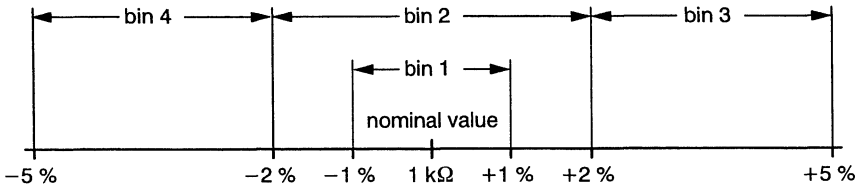

- ★ Instead of a nominal values with +/- limits in percent, the limits can also be entered directly as absolute values. Refer to **LIMITS** keyword.

Remote control commands:

Parameter As nominal value: BIN_REL
 In absolute limits: BIN_ABS

Resistance RESI
 Capacitance CAP
 Inductance INDU
 Impedance IMP
 Quality factor QUAL
 Dissipation factor DISS
 Phase angle PHA

Upper limit: LIM_HI xx

Lower limit: LIM_LO xx xx = numerical value

Bin number: BIN x x = 0 ... 9

Nominal value and tolerance in percent:

```
BIN_REL;RESI 1E3;LIM_LO -.5;LIM_HI .5;BIN 1;
      LIM_LO -1;LIM_HI 1;BIN 2;
      LIM_LO -1.5;LIM_HI 1.5;BIN 3;
```

Input as absolute value:

```
BIN_ABS;RESI;LIM_LO 0.95E3;LIM_HI 1.005E3;BIN 1;
      LIM_LO 0.90E3;LIM_HI 1.010E3;BIN 2;
      LIM_LO 0.85E3;LIM_HI 1.015E3;BIN 3;
```

BINNING

In this mode, the instrument checks the component to be measured according to the criteria for the bins entered beforehand; for instrument settings, see Section 4.6.2.4. If the component meets the criteria of a bin, that means, it is within a defined tolerance, the display shows the number of the bin. If the component cannot be allocated to any bin, the display shows **FAIL**.

External control lines can be connected by means of a handler interface (option). This enables an automatic binning device to be operated or an optical display with LED indicator lights.

 BINNING

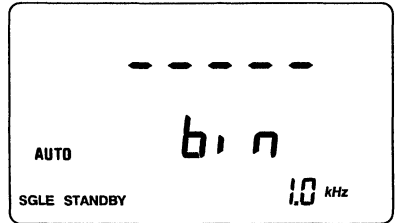

Insert component

TRIGGER

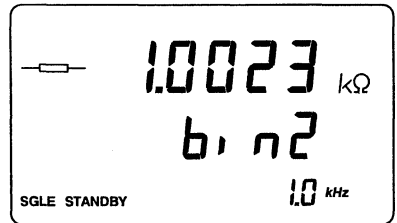

Remote control commands:

BINNING ON

C Capacitance

Refer to **Parameter**.

CAL Calibrate

The instrument was calibrated in the factory prior to shipment. The calibrating data are stored in an EEPROM and are taken into account during every measurement.

It is necessary to calibrate again after loss of data (replacing the EEPROM), after changing components during repair which might influence the measuring result or when the instrument does not comply with the technical specifications. In normal operation, recalibration once a year is sufficient. More details on this can be found in the SERVICE MANUAL.

The calibrating data are protected by a code number.

Pressing the keys inadvertently does not have any effect on the stored data. The display shows **CAL-1** or **CAL-2**. Press the **NORMAL** key to switch back to normal mode again.

D Dissipation Factor

Refer to **Parameter**.

DATA INPUT

Press this key to set the instrument to the input mode for binning data.

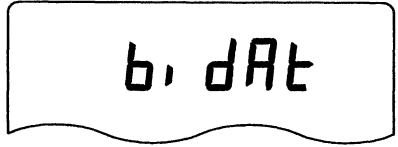
 DATA INPUT

To select a bin, refer to **BIN**.

To enter data for the bin, refer to **LIMITS**.

Remote control commands:

No direct command. Data can be entered directly via the interface.

Decimal Point

Refer to **Numerical Keypad**, end of the list.

Dimension

When the parameter which is to be used for binning has been selected, the instrument automatically sets the unit of measurement. When the number has been entered, the multiplier desired can be selected with key **k**, **M**, μ , **m**, **n** or **p**.

Resistances (R, Z): 10^3 (k), 10^6 (M)

Capacitances (C): 10^{-3} (m), 10^{-6} (μ), 10^{-9} (n), 10^{-12} (p)

Inductances (L): 10^3 (k), 10^{-3} (m), 10^{-6} (μ)

Q and D are factors without a unit of measurement.

With Φ (phase angle), the unit of measurement, degree, is not displayed.

 DATA INPUT

BIN

No



1



NOMINAL



R



1



M

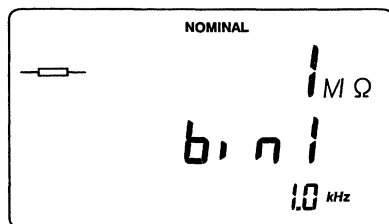

Remote control commands:

No direct command; the unit of measurement is automatically set according to the programmed parameter. The multiplier can be entered in exponential form: $1E3 = 1 \text{ k}\Omega$ with resistances, $10E-6 = 10 \text{ }\mu\text{F}$ with capacitances

ENTER

You must press the **ENTER** key to acknowledge when data sets are changed or new ones entered. The data are now stored in a buffer. They are lost when the instrument is turned off or when leaving bin programming by pressing a front panel key or by pressing the **BINNING** or **NORMAL** key. They have to be saved beforehand via the **STORE** function.

ENTER

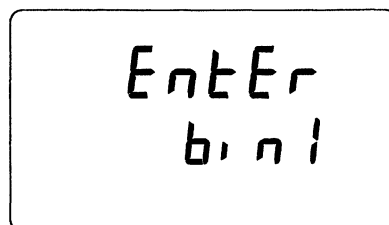

Remote control commands:

None; the terminator of a string is equivalent to an acknowledgment.

If a bin was selected, press the **ENTER** key to move step by step to other bins without having to press the **Nº** key and a digit.

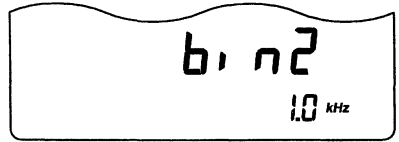

ENTER

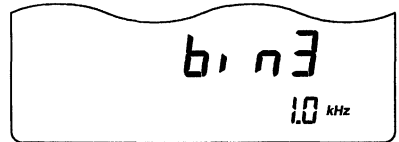

ENTER

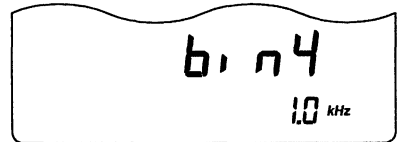

HIGH Upper Tolerance Limit

Refer to **LIMITS**.

k kilo

Refer to **Dimension**.

L Inductance

Refer to **Parameter**.



LIMITS Ranges for Binning



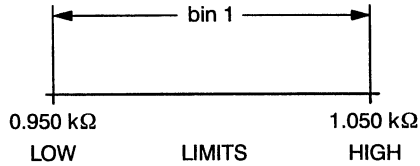



There are various methods for defining the limits for a bin:







Upper and lower limit as absolute values, for example:



 DATA INPUT

BIN
No 1
 

HIGH **R**
 
1 . 0 5 k
    

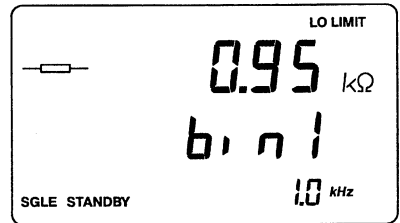
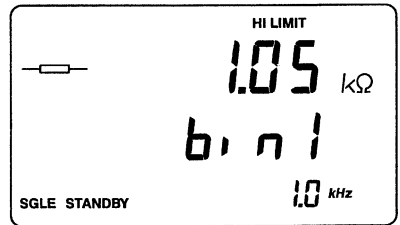
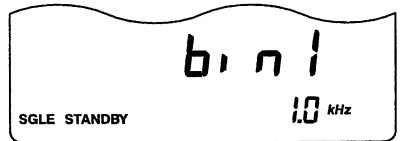

LOW **R**
 
. 9 5 k
   



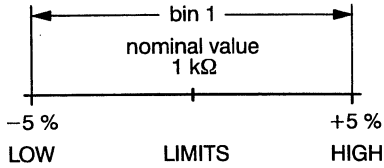

A nominal value and the upper and lower limit as a relative offset of the nominal value:





 DATA INPUT

BIN
No  1 

NOMINAL

R  **1**  **k** 

HIGH
 **.**  **5** 

LOW
 **.**  **5**  **+/-** 

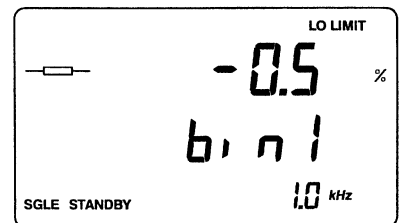
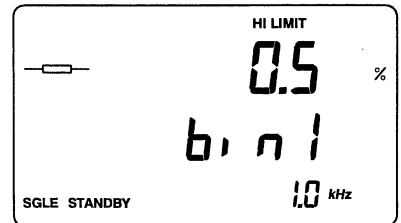
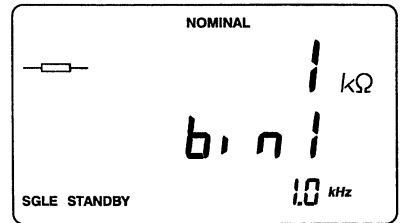
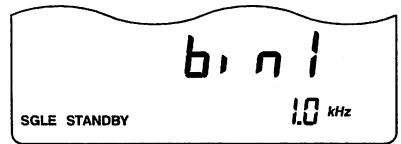

Remote control commands:

Input as absolute values:

```
BIN_ABS;RESI;LIM_LO 0.95e3;LIM_HI 1.005E3;BIN 1;
```

Nominal value and tolerance in percent:

```
BIN_REL;RESI 1E3;LIM_LO -.5;LIM_HI .5;BIN 1;
```

LOW Lower Tolerance Limit

Refer to **LIMITS**.

M Mega

Refer to **Dimension**.

m milli

Refer to **Dimension**.

n nano

Refer to **Dimension**.

NOMINAL Nominal Value

Refer to **LIMITS**.

NORMAL Normal Mode

You can return to normal mode by pressing this key if data input or binning was selected.

 **NORMAL**

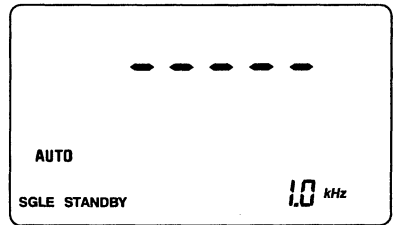

CONT
SINGLE

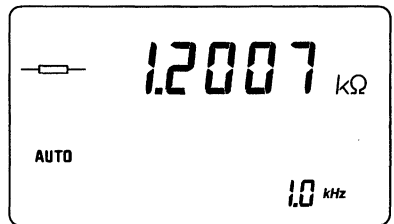
Remote control commands:

BIN OFF

p piko

Refer to **Dimension**.

Parameter

Before you enter the values for the binning limits, you must define to which parameter they must refer by pressing the appropriate key. This parameter must be used for the complete bin set, with the exception of bin 0.

R Resistance

Q Quality factor

Z Impedance

C Capacitance

D Dissipation factor

Φ Phase angle

L Inductance

 DATA INPUT

BIN

NO

1



NOMINAL

Z

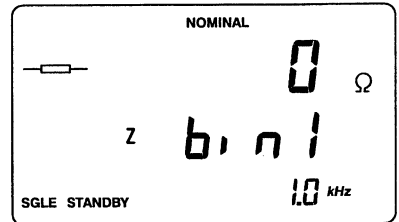
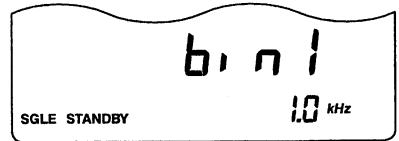

Remote control commands:

Resistance

RESI

Capacitance

CAP

Inductance

INDU

Impedance

IMP

Quality factor

QUAL

Dissipation factor

DISS

Phase angle

PHA

Q Quality Factor

Refer to **Parameter**.

R Resistance

Refer to **Parameter**.

RCL METER MODE Operating Mode

Keys **NORMAL**, **BINNING**, **DATA INPUT** are used to select the operating mode of the RCL Meter.

NORMAL: Normal measuring functions with operation via the keyboard of the instrument

BINNING: Instrument in the binning mode, components are classed according to limiting values entered beforehand

DATA INPUT: Instrument is ready for data input for binning criteria

The functions are described under the appropriate keyword.

Remote control commands:

Normal: BIN OFF

Binning: BIN ON

Data input: None; data can be entered directly

RECALL

Press the **RECALL** key and then a storage register number (0 to 9) to call up the stored data of a complete bin set including instrument settings.

 DATA INPUT

RECALL  1 

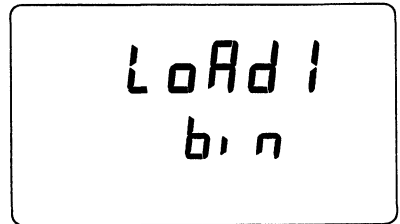

LoAd 1
bin

ENTER 

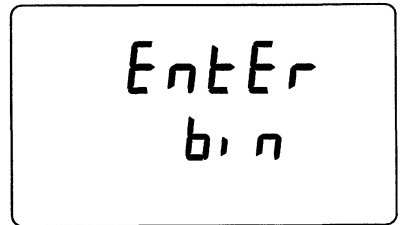

EntEr
bin

after 2 seconds

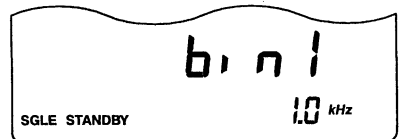

bin 1
1.0 kHz

SGLE STANDBY

Remote control commands:

BUF_RCL x x = 0 ... 9

loads contents of register x
into a separate buffer
for editing

BIN_RCL x x = 1 ... 9

loads contents of register x
into register 0 for binning

RUBOUT

You can delete inadvertently or erroneously entered digits individually by pressing the **RUBOUT** key.

NOMINAL



R



1



2



3



4



5

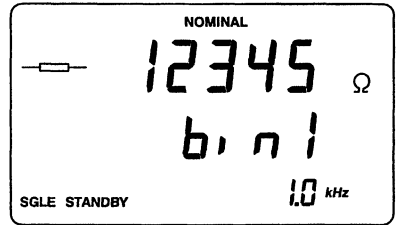

RUBOUT

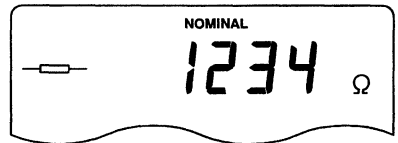

RUBOUT

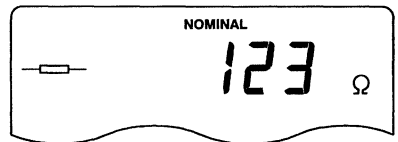

Press the **RUBOUT** and the **ENTER** key after selecting a bin number to delete **all values** of the bin.

Remote control commands:

No direct ones;

BIN_ERA x deletes the data set x

BUF_CLEAR deletes the input buffer

STORE

You can store ten data sets in storage registers 0 to 9. A data set contains the data of bins 1 to 9 and the selected instrument setting. These storage registers are not the same as those where the instrument settings are stored during keyboard operation.

Newly entered data for binning must be stored into registers 0 to 9 via the **STORE** function or by pressing the **BINNING** or **NORMAL** key into register 0. The **ENTER** key alone does not store the data.

To recall the data, refer to **RECALL**.

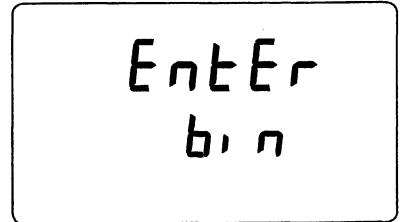
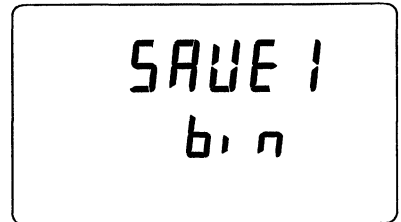

after 2 seconds

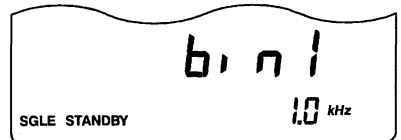

Remote control commands:

BIN_STO x x = 0 ... 9

Z Impedance

Refer to **Parameter**.

Numerical Keypad

- Keys **0** to **9** are used for:
 - Selecting a bin.
 - Inputting values for the bins.
 - Selecting a memory location for calling up or storing data sets.
- Decimal point for input of decimal values.
- The **+/-** key is used for inputting negative percentages for the bin limits or a negative phase angle.

Remote control commands: Numerical values in the data element of a program message

Φ Phase Angle Phi

Refer to **Parameter**.

μ micro

Refer to **Dimension**.

+/- Sign Key

Refer to **Numerical Keypad**.

INSTALLATION AND SAFETY INSTRUCTIONS IN FOREIGN LANGUAGES

INSTRUCCIONES DE INSTALACION Y DE SEGURIDAD (E)

ISTRUZIONI PER LA MESSA IN FUNZIONE E NORME DI SICUREZZA (I)

INSTRUCTIES MET BETREKKING TOT DE INSTALLATIE EN VEILIGHEID (NL)

INSTALLATIONSANVISNINGAR OCH SÄKERHETSFÖRESKRIFTER (S)

INSTALLATION AND SAFETY INSTRUCTIONS IN FOREIGN LANGUAGES

1	INSTRUCCIONES DE INSTALACION Y DE SEGURIDAD	(E)
1.1	INSTRUCCIONES DE SEGURIDAD	- 1 -
1.1.1	Reparación y mantenimiento	- 1 -
1.1.2	Puesta a tierra	- 2 -
1.1.3	Contactos y conexiones	- 2 -
1.1.4	Ajuste de la tensión de la red y fusibles	- 3 -
1.2	POSICION DE FUNCIONAMIENTO DEL APARATO	- 4 -
1.3	SUPRESION DE INTERFERENCIAS	- 4 -
1	ISTRUZIONI PER LA MESSA IN FUNZIONE E NORME DI SICUREZZA	(I)
1.1	NORME DI SICUREZZA	- 5 -
1.1.1	Riparazione e manutenzione	- 5 -
1.1.2	Messa a terra	- 6 -
1.1.3	Contatti e collegamenti	- 6 -
1.1.4	Predisposizione della tensione di aliment. e fusibili	- 7 -
1.2	POSIZIONE DI FUNZIONAM. DELL'APPARECCHIO	- 8 -
1.3	INTERFERENZE	- 8 -
1	INSTRUCTIES MET BETREKKING TOT DE INSTALLATIE EN VEILIGHEID	(NL)
1.1	VEILIGHEIDSINSTRUCTIES	- 9 -
1.1.1	Reparatie en onderhoud	- 9 -
1.1.2	Aarding	- 10 -
1.1.3	Aansluitingen en verbindingen	- 10 -
1.1.4	Netspanningsinstelling en zekeringen	- 11 -
1.2	GEBRUIKSPOSITIE VAN HET APPARAAT	- 12 -
1.3	RADIO-ONTSTORING	- 12 -

1	INSTALLATIONSANVISNINGAR OCH SÄKERHETSFÖRESKRIFTER	(S)
1.1	SÄKERHETSFÖRESKRIFTER	- 13 -
1.1.1	Reparation och underhåll	- 13 -
1.1.2	Skyddsjordning	- 14 -
1.1.3	Anslutningar	- 14 -
1.1.4	Nätspänningsomkoppling och säkringar	- 15 -
1.2	DRIFTSLÄGE	- 16 -
1.3	RADIOAVSTÖRNING	- 16 -

1	INSTALLATION AND SAFETY INSTRUCTIONS	(GB)
	See Chapter 1 of the English part.	

1	INSTALLATIONS- UND SICHERHEITSANWEISUNGEN	(D)
	Siehe Kapitel 1 des deutschen Teils.	

1	INSTRUCTIONS POUR L'INSTALLATION ET DE SECURITE	(F)
	Voir le chapitre 1 de la partie française.	

1 INSTRUCCIONES DE INSTALACION Y DE SEGURIDAD

1.1 INSTRUCCIONES DE SEGURIDAD

El aparato sale de fábrica, técnicamente, en perfectas condiciones de seguridad (ver cap. 1, Reference Manual). Para que se conserven estas condiciones, y para evitar riesgos en el uso, hay que seguir cuidadosamente las indicaciones siguientes.

1.1.1 Reparación y mantenimiento

Defectos y esfuerzos extraordinarios:

Si se piensa que el aparato ya no puede funcionar sin riesgo, hay que apagarlo y asegurarse de que no se ponga en funcionamiento inadvertidamente. Este es el caso:

- cuando el aparato presenta daños visibles,
- cuando el aparato ya no funciona,
- luego de haber sido sometido a esfuerzos excesivos de cualquier tipo (p.e. en el almacenaje o el transporte) que sobrepasan los límites permitidos.

Abrir el aparato:

Al abrir algunas tapas o al desmontar piezas con herramientas pueden quedar al descubierto partes bajo tensión eléctrica. También puede haber tensión en los puntos de conexión. Antes de abrir el aparato hay que desconectarlo de todas las fuentes de alimentación.

Si es inevitable realizar un **calibrado, mantenimiento o reparación con el aparato abierto** que se encuentra bajo tensión, sólo debe hacerlo un técnico cualificado que conozca los riesgos que existen. Los condensadores del aparato pueden seguir estando cargados aún cuando esté haya sido desconectado de todas las fuentes de alimentación.

1.1.2 Puesta a tierra

Antes de hacer alguna conexión hay que conectar el aparato a un contactor de protección mediante el cable de alimentación de tres conductores.

El enchufe de la red debe ser insertado sólo en tomacorrientes con contacto de seguridad de tierra.

No se deben anular estas medidas de seguridad, p.e. usando un cable de extensión sin contactor de protección.

La puesta protectora a tierra a través de los contactos de medición en la placa frontal, a través de los 4 contactos de la toma a la cual se aplica el potencial de tierra del circuito o a través del contacto exterior de la toma o de la clavija es inadmisibile.

ADVERTENCIA: Toda interrupción del contactor de protección dentro o fuera del aparato, o la separación de la conexión de la puesta protectora a tierra es peligrosa.
Se prohíbe hacer la interrupción expresamente.

1.1.3 Contactos y conexiones

El potencial de tierra del circuito se aplica a 4 de los 8 contactos de la toma, estando éste conectado en paralelo a la carcasa del aparato por medio de condensadores y resistencia; el contacto exterior de la toma está unido a la carcasa del aparato. De esta forma se evitan zumbidos y se obtiene una clara puesta a tierra de HF.

Si al efectuar una medición se observa que el potencial de tierra del circuito eléctrico difiere del potencial de tierra de protección, se ha de tener en cuenta que los 4 contactos de la toma no deban estar conectados a tensiones que sean peligrosas al menor contacto.

1.1.4 Ajuste de la tensión de la red y fusibles

Antes de enchufar el aparato a la red hay que verificar si éste está ajustado a la tensión de la red local.

ADVERTENCIA: Si hay que adaptar el enchufe de la red a las circunstancias del lugar, este trabajo debe realizarlo sólo un técnico cualificado.

Al salir de fábrica el aparato está ajustado a una de las tensiones de red siguientes:

Tipo de aparato	Nro. de código	Tensión de red	Cable suministrado
PM6304 o PM6304C	9452 x63 04xx1	220 V	Europa
PM6304 o PM6304C	9452 x63 04xx3	120 V	Norteamérica
PM6304 o PM6304C	9452 x63 04xx4	240 V	Inglaterra (U.K.)
PM6304 o PM6304C	9452 x63 04xx5	220 V	Suiza
PM6304 o PM6304C	9452 x63 04xx8	240 V	Australia

En la parte trasera del aparato se indica la tensión de red ajustada y el valor del fusible correspondiente.

Hay que tener en cuenta de emplear solamente fusibles con la tensión nominal indicada y del tipo especificado para recambio. Se prohíbe el empleo de fusibles reparados o cortocircuitar el porta-fusibles. El cambio del fusible sólo deberá realizarlo un técnico cualificado, que conozca los riesgos que existen.

ADVERTENCIA: Cuando se cambia un fusible y cuando se ajusta el aparato a otra tensión, éste debe ser desconectado de todas las fuentes de alimentación.

El aparato se puede ajustar a las tensiones de red siguientes: 100 V, 120 V, 220 V y 240 V en corriente alterna. Se puede hacer la regulación de estas tensiones nominales con el selector de tensión (combinado con el enchufe en la pared trasera del aparato).

El fusible se encuentra en un soporte en el mismo sitio. Para ajustar la tensión de la red o para sustituir el fusible hay que desconectar el aparato de la red y abrir con un destornillador la tapa (ver dibujo).

La tensión adecuada se elige girando el selector de tensión. Si hace falta, se debe montar el fusible correspondiente en lugar del que está instalado en el soporte del fusible – T0.2A o T0.4A (IEC127) o T0.25A o T0.5A (CSA/UL198G).

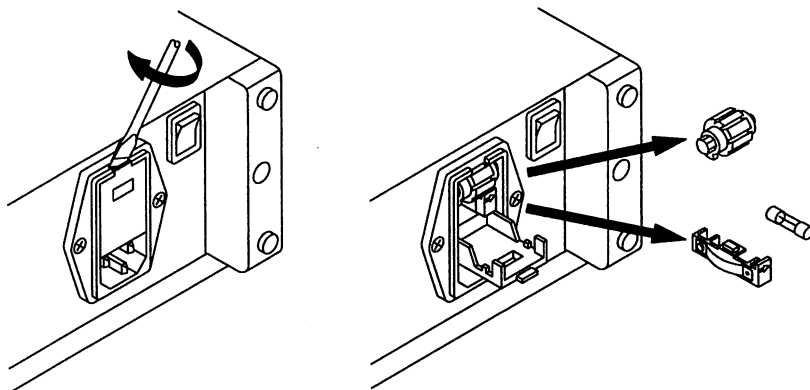

1.2 POSICION DE FUNCIONAMIENTO DEL APARATO

El aparato puede funcionar en las posiciones indicadas en el capítulo 1, Reference Manual. Si la horquilla de soporte está cerrada, el aparato puede utilizarse en posición inclinada. Los datos técnicos del capítulo 1, Reference Manual, se refieren a las posiciones indicadas. Se ha de tener cuidado de no cubrir las aberturas de ventilación del aparato. El aparato no se debe colocar nunca sobre una superficie que produzca o irradie calor ni exponerlo a los rayos directos del sol.

1.3 SUPRESION DE INTERFERENCIAS

En el aparato se han suprimido cuidadosamente todas las interferencias, habiéndose sometido éste también a prueba. Al conectarlo a unidades básicas o a otras unidades periféricas cuyas interferencias no se han suprimido correctamente, pueden generarse interferencias que en algunos casos exigirán medidas adicionales para suprimirlas.

1 ISTRUZIONI PER LA MESSA IN FUNZIONE E NORME DI SICUREZZA

1.1 NORME DI SICUREZZA

L'apparecchio viene fornito dalla fabbrica perfettamente sicuro e funzionante dal punto di vista tecnico (vedi Cap. 1, Reference Manual). Per preservarlo in condizioni ottimali e garantirne un corretto funzionamento, attenersi scrupolosamente alle seguenti istruzioni.

1.1.1 Riparazione e manutenzione

Funzionamento anomalo e sollecitazioni eccessive:

Qualora il funzionamento non risultasse regolare, spegnere subito l'apparecchio e prevenirne ogni accensione accidentale.

Le precauzioni di cui sopra vanno adottate nei seguenti casi:

- se l'apparecchio mostra dei danni visibili,
- se l'apparecchio non funziona più,
- se l'apparecchio è stato sottoposto a sollecitazioni (ad esempio durante il magazzino, il trasporto, ecc.) oltre i limiti di tolleranza ammessi.

Apertura dell'apparecchio:

Se i coperchi o alcune parti dell'apparecchio vengono rimossi con appositi attrezzi, può darsi che risultino esposti dei componenti sotto tensione. Anche i punti di connessione possono essere sotto tensione. Prima di aprire l'apparecchio occorre quindi disinnestarlo dalle relative prese di corrente.

Se fosse necessario eseguire interventi di **calibrazione, manutenzione o riparazione con l'apparecchio aperto** e sotto tensione, rivolgersi a personale specializzato che conosca bene i probabili rischi nelle procedure da adottare. Potrebbe darsi che i condensatori dentro all'apparecchio siano ancora carichi anche se l'apparecchio è stato disinnestato dalle relative prese di corrente.

1.1.2 Messa a terra

Prima di eseguire un qualsiasi collegamento, mediante il cavo di alimentazione tripolare l'apparecchio deve essere allacciato ad un conduttore di protezione.

La spina del cavo di alimentazione deve essere inserita soltanto in una presa munita di contatto di messa a terra.

Questa norma resta comunque valida, anche se si utilizza un cavo di prolunga senza conduttore di protezione.

I contatti di misura sulla piastra anteriore o i quattro contatti della presa su cui viene applicato il potenziale di terra del circuito di alimentazione, o il contatto esterno della presa/spina, o le prese alla piastra posteriore non devono essere utilizzati per collegare un conduttore di terra protettivo.

ATTENZIONE: E' estremamente pericoloso interrompere il conduttore di protezione interno o esterno all'apparecchio o i contatti di messa a terra. Evitare quindi di farlo intenzionalmente.

1.1.3 Contatti e collegamenti

Il potenziale di terra del circuito di alimentazione viene applicato a quattro degli otto contatti della presa e condotto alla carcassa dell'apparecchio tramite condensatori e una resistenza collegati in parallelo; il contatto esterno della presa viene collegato alla carcassa dell'apparecchio. In tal modo, viene realizzato un collegamento di messa a terra RF univoco esente da interferenze.

Se il potenziale di terra del circuito all'interno di una determinata configurazione fosse differenziato dal potenziale di messa a terra di protezione, occorre accertarsi che i quattro contatti della presa non siano sotto tensione.

1.1.4 Predisposizione della tensione di alimentazione e fusibili

Prima di collegare la spina di alimentazione alla presa, controllare che l'apparecchio sia predisposto per la tensione di rete locale.

ATTENZIONE: L'eventuale adattamento della spina di alimentazione alle condizioni locali va effettuata esclusivamente da personale specializzato.

L'apparecchio fornito dalla fabbrica è predisposto per uno dei seguenti valori di tensione di rete:

Tipo di apparecchio	N° di codice	Tensione	Cavo di alimentazione fornito in dotazione
PM6304 op. PM6304C	9452 x63 04xx1	220 V	Europa
PM6304 op. PM6304C	9452 x63 04xx3	120 V	Norteamérica
PM6304 op. PM6304C	9452 x63 04xx4	240 V	Inghilterra (U.K.)
PM6304 op. PM6304C	9452 x63 04xx5	220 V	Suiza
PM6304 op. PM6304C	9452 x63 04xx8	240 V	Australia

Il valore della tensione di rete predisposto e la portata del fusibile sono indicati sul retro dell'apparecchio.

Si un fusibile deve essere sostituito, fare attenzione a utilizzarne uno caratterizzato dalla portata nominale prescritta e di tipo idoneo. Non è consentito utilizzare fusibili riparati e/o cortocircuitare il porta-fusibile. Il fusibile può essere sostituito solo da personale specializzato che conosca bene i potenziali rischi esistenti negli interventi di questo tipo.

ATTENZIONE: Per sostituire un fusibile o predisporre un diverso valore della tensione di alimentazione occorre disinserire l'apparecchio dalle relative presa di corrente.

L'apparecchio può essere predisposto per i seguenti valori della tensione di alimentazione: 100 V, 120 V, 220 V e 240 Vca. Questi valori nominali di tensione possono essere predisposti con il selettore della tensione (in corrispondenza della presa di alimentazione sul retro dell'apparecchio).

Il fusibile è collocato in un supporto nello stesso posto. Per impostare il valore della tensione di rete o per sostituire il fusibile, occorre disinnestare il cavo di alimentazione e aprire con un cacciavite l'aletta di chiusura (vedere il disegno).

Selezionare il valore di tensione richiesto girando la rotella di regolazione. Se necessario, sostituire il vecchio fusibile con uno nuovo – T0.2A oppure T0.4A (IEC127) oppure T0.25A oppure T0.5A (CSA/UL198G).

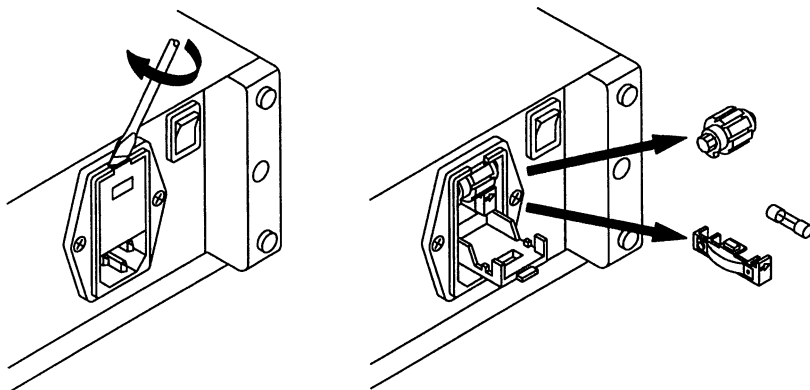

1.2 POSIZIONE DI FUNZIONAMENTO DELL'APPARECCHIO

L'apparecchio può essere installato nelle posizioni indicate nel Capitolo 1, Reference Manual. Abbassando la squadretta di supporto, l'apparecchio può essere usato in posizione inclinata. I dati tecnici riportati nel Capitolo 1, Reference Manual, valgono per le posizioni indicate. Attenzione che le aperture di ventilazione dell'apparecchio non vengano coperte. L'apparecchio non deve essere mai collocato su una superficie surriscaldabile o che produca irradiazioni, né essere esposto ai raggi diretti del sole.

1.3 INTERFERENZE

L'apparecchio è stato realizzato per garantire un funzionamento esente da interferenze. Se viene utilizzato congiuntamente a unità base e a unità periferiche non dotate delle stesse protezioni, ne possono derivare interferenze che richiederanno ulteriori interventi.

1 INSTRUCTIES MET BETREKKING TOT DE INSTALLATIE EN VEILIGHEID

1.1 VEILIGHEIDSINSTRUCTIES

Het apparaat heeft de fabriek in een onberispelijke veiligheidstechnische toestand verlaten (zie hoofdstuk 1, Reference Manual). Voor het behoud van deze toestand en het risicoloze gebruik dienen de onderstaande instructies nauwkeurig te worden opgevolgd.

1.1.1 Reparatie en onderhoud

Storingen en uitzonderlijke omstandigheden

Wanneer verondersteld moet worden dat een risicoloos gebruik niet meer mogelijk is, dient het apparaat buiten gebruik gesteld en tegen een ongewenst gebruik beveiligd te worden. Deze situatie doet zich voor

- wanneer het apparaat zichtbare beschadigingen vertoont,
- wanneer het apparaat niet meer functioneert,
- na blootstelling aan excessieve omstandigheden van welke aard dan ook (bij voorbeeld bij opslag, transport) die de toelaatbare grenzen overschrijden.

Openen van het apparaat

Bij het openen van afdekkingen of bij het met behulp van gereedschap verwijderen van onderdelen, kan het risico van contact met spanningvoerende delen ontstaan. Ook kan er spanning op aansluitpunten aanwezig zijn. Het apparaat mag pas geopend worden nadat het van alle spanningsbronnen losgenomen is.

Wanneer **ijk-, onderhouds- of herstelwerkzaamheden aan een open en onder spanning staand apparaat** onvermijdelijk zijn, mogen deze slechts worden uitgevoerd door een vakman die weet met welke gevaren dit gepaard gaat. In het apparaat aanwezige condensators kunnen nog geladen zijn, ook wanneer het apparaat van alle spanningsbronnen is losgenomen.

1.1.2 Aarding

Alvorens men een verbinding tot stand brengt, dient men het apparaat met behulp van een drieadelige kabel met een veiligheidsaarddraad te verbinden. De netstekker mag slechts op een stopcontact met randaarde worden aangesloten.

Deze veiligheidsmaatregel mag niet onwerkzaam gemaakt worden, bij voorbeeld door het gebruik van een verlengsnoer dat niet van een veiligheidsaarddraad voorzien is.

Een beschermde aarde aansluiting via de meetansluitingen aan de voorkant, over de 4 steker contacten welke op schakelnulpunt-potentiaal liggen, via het externe contact van de steker (stekerkhuis) of van de steker, of via de stekers aan de achterkant is niet toegestaan.

WAARSCHUWING: Elke onderbreking van de beschermende aardleiding, hetzij binnen of buiten het apparaat, of de scheiding ten opzichte van de aardleiding zijn gevaarlijk. Een opzettelijke onderbreking is verboden.

1.1.3 Aansluitingen en verbindingen

Het aardpotentiaal van de stroomkringen wordt aan 4 van de 8 contacten van de steker verbonden, en is met het huis verbonden via parallel aangesloten condensators en weerstand; het externe contact van de steker (stekerkhuis) is met de behuizing verbonden.

Op deze manier wordt een duidelijke bromvrije HF-aarding tot stand gebracht.

Wanneer in een meetopstelling het schakelnulpunt-potentiaal van een stroomkring afwijkt van het beschermde aardpotentiaal, dan dient men er op bedacht te zijn, dat de 4 contacten van de steker geen gevaarlijke spanningen mogen voeren!

1.1.4 Netspanningsinstelling en zekeringen

Alvorens men de netstekker op het lichtnet aansluit, dient men zich ervan te vergewissen dat het apparaat op de plaatselijke netspanning is afgesteld.

WAARSCHUWING: Wanneer de netstekker aan de plaatselijke situatie moet worden aangepast, mag deze aanpassing slechts door een vakman worden uitgevoerd.

Bij het verlaten van de fabriek is het apparaat op een van de volgende netspanningen afgesteld:

Type apparaat	Codenummer	Netspanning	Meegeleverde netkabel
PM6304 of PM6304C	9452 x63 04xx1	220 V	Europa
PM6304 of PM6304C	9452 x63 04xx3	120 V	Noord-Amerika
PM6304 of PM6304C	9452 x63 04xx4	240 V	Engeland (U.K.)
PM6304 of PM6304C	9452 x63 04xx5	220 V	Zwitserland
PM6304 of PM6304C	9452 x63 04xx8	240 V	Australië

Op de achterwand van het apparaat zijn de netspanning waarop het apparaat is afgesteld en de hierbij behorende zekering vermeld.

Men dient erop te letten dat men bij het vervangen van een zekering slechts een exemplaar met de gespecificeerde nominale stroomsterkte en van het gespecificeerde type mag gebruiken. Het gebruik van gerepareerde zekeringen en/of het kortsluiten van de zekeringhouder zijn verboden. De zekering mag slechts vervangen worden door een vakman die weet met welke gevaren dit gepaard gaat.

WAARSCHUWING: Bij het vervangen van een zekering en bij het instellen op een andere netspanning moet het apparaat van alle spanningsbronnen worden losgenomen.

Het apparaat kan op de volgende netspanningen worden ingesteld: 100 volt, 120 volt, 220 volt en 240 volt wisselspanning. Deze nominale spanningen kunnen met de spanningskiezer (die gecombineerd is met de netaansluitbus op de achterwand) worden ingesteld.

De zekering bevindt zich in een houder op dezelfde plaats. Voor het instellen van de netspanning of het vervangen van een zekering moet de voedingskabel losgenomen worden en het afdekscherm met een schroevendraaier worden verwijderd. (zie tekening).

Men kiest de juiste spanning door het verdraaien van het instelwiel. Indien nodig moet de bijbehorende zekering in plaats van de reeds aanwezige zekering worden aangebracht – T0.2A of T0.4A (IEC127) of T0.25A of T0.5A (CSA/UL198G).

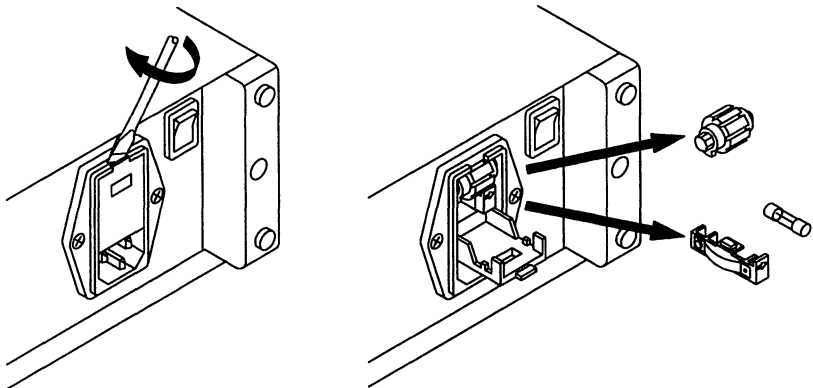

1.2 GEBRUIKSPROPOSITIE VAN HET APPARAAT

Het apparaat mag in de in hoofdstuk 1, Reference Manual beschreven posities gebruikt worden. Wanneer de stelvoet naar beneden geklapt is, kan het apparaat in een schuingeplaatste positie gebruikt worden. De technische specificatie in hoofdstuk 1, Reference Manual is van toepassing op de gespecificeerde gebruiksposities. Het erop dat de ventilatieopeningen van het apparaat niet afgedekt worden. Het apparaat nooit installeren op een oppervlak dat warmte genereert of uitstraalt, en het evenmin aan rechtstreekse zonnestraling blootstellen.

1.3 RADIO-ONTSTORING

Wat radio-ontstoring betreft is het apparaat zorgvuldig ontstoord en gecontroleerd. Bij het schakelen in combinatie met basisunits die niet correct onstoord zijn en met andere perifere apparatuur, kan radiostoring optreden. In de desbetreffende gevallen maakt dit aanvullende maatregelen op radio-ontstoring gebied noodzakelijk.

1 INSTALLATIONSANVISNINGAR OCH SÄKERHETSFÖRESKRIFTER

1.1 SÄKERHETSFÖRESKRIFTER

Detta instrument uppfyllde gällande säkerhetsföreskrifter (se kapitel 1, Reference Manual) när det lämnade fabriken. Följ nedanstående säkerhetsföreskrifter så förblir instrumentet säkert under normal drift.

1.1.1 Reparation och underhåll

Är instrumentet är trasigt eller har utsatts för onormal förhållanden?

Om du misstänker att det inte går att använda instrumentet på ett säkert sätt, sluta använda det och förhindra även andra att använda det.

Detta skall göras då:

- det finns synliga skador på instrumentet
- instrumentet inte längre fungerar
- när instrumentet utsatts för förhållanden som går utanför specifikationen, till exempel vid lagring eller transport.

Öppning av instrumentet

Om du tar av kåpan på instrumentet eller tar bort delar som måste demonteras med verktyg, så blir spänningsförande delar direkt åtkomliga. Drag alltid ur nätsladden och koppla bort alla andra spänningskällor innan du öppnar instrumentet.

När det är nödvändigt att **kalibrera, underhålla eller reparera ett instrument** med spänningen inkopplad, måste detta göras av behörig personal som känner till riskerna med arbetet. Kom ihåg att även om du kopplat ifrån alla spänningskällor så kan kondensatorer i instrumentet behålla sin laddning i några sekunder.

1.1.2 Skyddsjordning

Innan du ansluter några andra kablar till instrumentet, jorda det genom att ansluta den trepoliga nätkabeln till en jordad nätkontakt. Instrumentet får aldrig anslutas till en ojordad kontakt! Bryt inte heller jordningen genom att använda ojordade skarvsladdar. Skyddsjorden får endast anslutas via nätkabeln som är ansluten till nätbrunnens jordstift.

WARNING: Om du bryter skyddsjorden i eller utanför instrumentet blir det farligt att använda. Att avsiktligt bryta skyddsjorden är absolut förbjudet.

1.1.3 Anslutningar

Signaljorden är ansluten till fyra stift i den åttapoliga kontakten. Dessa stift är anslutna till kåpan via parallellkopplade kondensatorer och motstånd. Kontaktdonets ytterhölje är direktanslutet till kåpan. På detta sätt undviks brum och instrumentet får god RF-jordning.

Om mätobjektets signaljord inte är på samma potential som skyddsjorden, måste du se till att det inte finns någon spänning mellan de fyra signaljordsstiften och skyddsjorden, till exempel genom att använda skyddstransformator.

1.1.4 Nätspänningsomkoppling och säkringar

Innan du ansluter nätsladden till vägguttaget måste du kontrollera att instrumentet är inställt för rätt nätspänning.

VARNING: Om kontakt på nätsladden måste bytas, överlåt detta till behörig elektriker.

När instrumentet lämnar fabriken är spänningsomkopplaren inställd enligt följande:

Typnummer	Beställningsnummer	Nätspänning	Medlevererad nätkabel
PM6304 och PM6304C	9452 x63 04xx1	220 V	Europeisk
PM6304 och PM6304C	9452 x63 04xx3	120 V	Nordamerikansk
PM6304 och PM6304C	9452 x63 04xx4	240 V	Brittisk (U.K.)
PM6304 och PM6304C	9452 x63 04xx5	220 V	Schweizisk
PM6304 och PM6304C	9452 x63 04xx8	240 V	Australiensisk

Du kan se inställd nätspänning och säkringsvärde på bakpanelen.

Om säkringen måste bytas, använd endast säkringar av specificerad typ och med rätt strömstyrka. Det är absolut förbjudet att reparera säkringen eller att kortsluta säkringshållaren. Säkringsbyte får endast utföras av kvalificerad personal som är medveten om riskerna.

VARNING: Koppla alltid ur nätsladden och alla andra spänningskällor innan du ändrar nätspänningsomkopplaren eller byter säkring.

Instrumentet kan ställas in för 100 V, 120 V, 220 V och 240 V växelström. Både spänningsomkopplaren och säkringshållaren sitter i nätbrunnen på bakpanelen.

Om du skall ändra spänningsområde eller byta säkring, så drar du ur nätkabeln ur nätbrunnen och öppnar sedan skyddslocket med en skruvmejsel (se bild).

Välj rätt nätspänning genom att ta ut rullen, vända den så att den spänning du vill ha visas utåt och sedan sätta in den igen. Du kan vara tvungen att byta säkring vid val av ny spänning. Drag ut säkringshållaren och byt till rekommenderad säkring – T0.2A resp. T0.4A (IEC127) och T0.25A resp. T0.5A (CSA/UL198G).

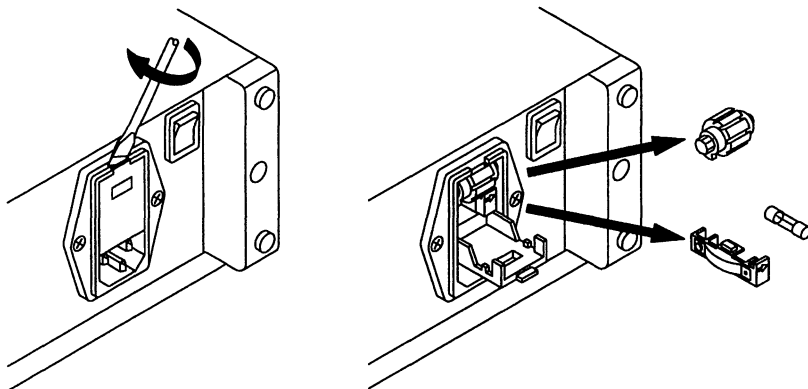

1.2 DRIFTSLÄGE

I kapitel 1, Reference Manual, kan du se vilka lägen instrumentet får användas i. Instrumentet kan vinklas upp till en bekväm betraktningvinkel genom att handtaget fälls ned. Specifikationspunkterna i kapitel 1, Reference Manual, garanteras i alla godkända driftslägen. Se till att ventilations hållen inte är blockerade. Ställ aldrig instrumentet på en yta som avger värme, inte heller i direkt solljus.

1.3 RADIOAVSTÖRNING

Radiostörningar som genereras av instrumentet är noggrant dämpade och avstörningen är noggrant kontrollerad. Om instrumentet kopplas samman med dåligt avstörda basenheter eller andra enheter, kan det genereras radiostörningar som behöver yttre avstörning.

FIGURES

APPENDIX

DIAGRAMS AND FORMULAS

TABLE FOR STORAGE REGISTER CONTENTS

LIMITED WARRANTY & LIMITATION OF LIABILITY

DECLARATION OF CONFORMITY

SERVICES CENTERS

If you are interested in mathematics the following two pages show the phasor diagrams and formulas for the various components as an appendix.

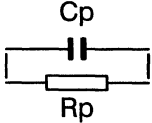

$$Y = \frac{1}{R_p} + j\omega C_p$$

$$Z = \frac{R_p (1 - j\omega C_p R_p)}{1 + (\omega C_p R_p)^2}$$

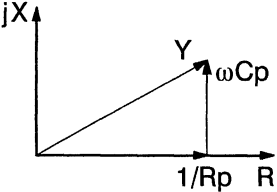

$$D = \frac{1}{\omega C_p R_p}$$

$$C_s = (1 + D^2) \times C_p \quad R_s = \frac{D^2}{1 + D^2} \times R_p$$

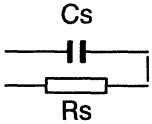

$$Z = R_s - j \frac{1}{\omega C_s}$$

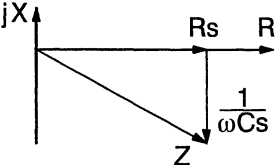

$$D = \omega C_s R_s$$

$$C_p = \frac{1}{1 + D^2} \times C_s \quad R_p = \frac{1 + D^2}{D^2} \times R_s$$

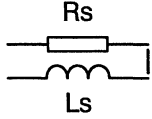

$$Z = R_s + j\omega L_s$$

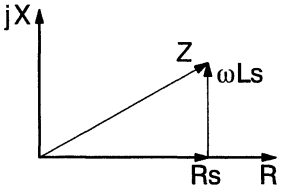

$$D = \frac{R_s}{\omega L_s}$$

$$L_p = (1 + D^2) \times L_s \quad R_p = \frac{1 + D^2}{D^2} \times R_s$$

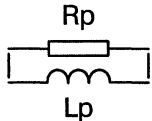

$$Y = \frac{1}{R_p} - j\frac{1}{\omega L_p} \quad Z = \frac{R_p (1 + jR_p/\omega L_p)}{1 + (R_p/\omega L_p)^2}$$

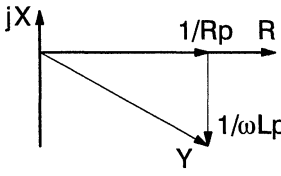

$$D = \frac{\omega L_p}{R_p}$$

$$L_s = \frac{1}{1 + D^2} \times L_p \quad R_s = \frac{D^2}{1 + D^2} \times R_p$$

Register No. <input type="checkbox"/> 1 <input type="checkbox"/> 2 <input type="checkbox"/> 3 <input type="checkbox"/> 4 <input type="checkbox"/> 5 <input type="checkbox"/> 6 <input type="checkbox"/> 7 <input type="checkbox"/> 8 <input type="checkbox"/> 9			
Bins	LOW LIMIT	Nominal Value	HIGH LIMIT
Bin 1			
Bin 2			
Bin 3			
Bin 4			
Bin 5			
Bin 6			
Bin 7			
Bin 8			
Bin 9			
Bin 0			

Instrument Settings

Measuring: AUTO Q D Z Φ

Test Signal Frequency: _____ kHz _____ Hz

Test Signal Voltage: HIGH LOW NORMAL

DC BIAS: ON OFF EXT _____ V

Used for: _____

LIMITED WARRANTY & LIMITATION OF LIABILITY

Each Fluke product is warranted to be free from defects in material and workmanship under normal use and service. The warranty period is one year and begins on the date of shipment. Parts, product repairs and services are warranted for 90 days. This warranty extends only to the original buyer or end-user customer of a Fluke authorized reseller, and does not apply to fuses, disposable batteries or to any product which, in Fluke's opinion, has been misused, altered, neglected or damaged by accident or abnormal conditions of operation or handling. Fluke warrants that software will operate substantially in accordance with its functional specifications for 90 days and that it has been properly recorded on non-defective media. Fluke does not warrant that software will be error free or operate without interruption.

Fluke authorized resellers shall extend this warranty on new and unused products to end-user customers only but have no authority to extend a greater or different warranty on behalf of Fluke. Warranty support is available if product is purchased through a Fluke authorized sales outlet or Buyer has paid the applicable international price. Fluke reserves the right to invoice Buyer for importation costs of repair/replacement parts when product purchased in one country is submitted for repair in another country.

Fluke's warranty obligation is limited, at Fluke's opinion, to refund of the purchase price, free of charge repair, or replacement of a defective product which is returned to an Fluke authorized service center within the warranty period.

To obtain warranty service, contact your nearest Fluke authorized service center or send the product, with a description of the difficulty, postage and insurance prepaid (FOB Destination), to the nearest Fluke authorized service center. Fluke assumes no risk for damage in transit. Following warranty repair, the product will be returned to Buyer, transportation prepaid (FOB Destination). If Fluke determines that the failure was caused by misuse, alteration, accident or abnormal condition of operation or handling, Fluke will provide an estimate of repair costs and obtain authorization before commencing the work. Following repair, the product will be returned to the Buyer transportation prepaid and the Buyer will be billed for the repair and return transportation charges (FOB Shipping Point).

THIS WARRANTY IS BUYER'S SOLE AND EXCLUSIVE REMEDY AND IS IN LIEU OF ALL OTHER WARRANTIES, EXPRESS OR IMPLIED, INCLUDING BUT NOT LIMITED TO ANY IMPLIED WARRANTY OF MERCHANTABILITY OR FITNESS FOR A PARTICULAR PURPOSE. FLUKE SHALL NOT BE LIABLE FOR ANY SPECIAL, INDIRECT, INCIDENTAL OR CONSEQUENTIAL DAMAGES OR LOSSES, INCLUDING LOSS OF DATA, WHETHER ARISING FROM BREACH OF WARRANTY OR BASED ON CONTRACT, TORT, RELIANCE OR ANY OTHER THEORY.

Since some countries or states do not allow limitation of the term of an implied warranty, or exclusion or limitation of incidental or consequential damages, the limitations and exclusions of this warranty may not apply to every buyer. If any provision of this Warranty is held invalid or unenforceable by a court of competent jurisdiction, such holding will not affect the validity or enforceability of any other provision.

product32994rjm

Fluke Corporation
P.O. Box 9090
Everett, WA
98206-9090
USA

or

Fluke Industrial B.V.
P.O. Box 680
7600 AR
Almelo
The Netherlands

FLUKE®

DECLARATION OF CONFORMITY
for

FLUKE
Programmable Automatic RCL Meter
PM 6304

Manufacturer

Fluke Industrial B.V.
Lelyweg 1
7602EA Almelo
The Netherlands

Statement of Conformity

Based on test results using appropriate standards, the product is in conformity with
Electromagnetic Compatibility Directive 89/336/EEC
Low Voltage Directive 73/23/EEC

Sample tests

Standards used:

EN 50081-1 (1992)
Electromagnetic Compatibility Generic Emission Standard:
EN 55011 Group I ClassB

EN 50082-1 (1992)
Electromagnetic Compatibility Generic Immunity Standard:
EN 61000-4-2, -3 and -4

EN 61010-1 (1994) CAT II Pollution Degree 2
Safety Requirements for Electrical Equipment for Measurement,
Control, and Laboratory Use:

The tests have been performed in a typical configuration.

This Conformity is indicated by the symbol , i.e. "Conformité européenne".

SERVICE CENTERS

Argentina

Viditec S.A.
Lacarra 234
Buenos Aires CP 1407
Phone: +54-1-636-1200
Fax: +54-1-636-2185

Australia

Philips Scientific & Industrial,
Pty., Ltd.
34 Waterloo Road
North Ryde, N.S.W. 2113
Phone: +61-2-888-8222
Fax: +61-2-888-0440

Austria

Fluke Vertriebsges GmbH
Südrandstraße 7
P.O. Box 10
A 1232 Wien
Phone: +43-1-61410-30
Fax: +43-1-61410-10

Bahrain

Mohammed Fakhroo & Bros.
P.O. Box 439 Bahrain
Phone: +973-253529
Fax: +973-275996

Belgium

N.V. Fluke Belgium S.A.
Sales & Service Department
Langeveldpark - Unit 5 & 7
P. Basteleusstraat 2 - 4 - 6
1600 St. Pieters-Leeuw
Phone: +32-2-331-2777
[Ext 218]
Fax: +32-2-331-1489

Bolivia

Coasin Bolivia S.R.L.
Casilla 7295
Calle Ayacucho No. 208
Edificio Flores, 5to. Piso
La Paz
Phone: +591-2-317531
Fax: +591-2-317545

Brazil

Sistest
Av. Ataulfo De Paiva
135 S/ 1117 - Leblon
22.449-900 - Rio De Janeiro
Phone: +55-21-259-5755
Fax: +55-21-259-5743

Brazil

Sigtron Instrumentos E. Servicos
Ltda
Rua Alvaro Rodrigues
269 - Brooklin
Sao Paulo
Phone: +55-11-240-7359
Fax: +55-11-533-3749

Brazil

Philips Medical Syst., Ltda.
Av. Interlagos North
3493 - Campo Grande
04661-200 Sao Paulo S.P.
Phone: +55-11-523-4811
Fax: +55-11-524-4873 (ID2148)

Bulgaria

Ac Sophilco
Customer Support Services
P.O. Box 42
1309 Sofia
Phone: +359-2-292-1815
Fax: +359-2-292-1915

Canada

Fluke Electr. Canada, Inc.
400 Britannia Road East, Unit #1
Mississauga, Ontario
L4Z 1X9
Phone: +1-905-890-7600
Fax: +1-905-890-6866

Chile

Intronica
Instrumentacion Electronica
S.A.C.I
Guardia Vieja 181 Of. 503
Casilla 16500
Santiago 9
Phone: +56-2-232-3888
Fax: 56-2-231-6700

China

Fluke Int'l Corporation
Room 2111 Scite Tower
Jiangumenwai Dajie
Beijing 100004, Prc
Phone: +86-10-512-3436
Fax: +86-10-512-3437

China

China Academy Of Science
Guangzhou Institute Of
Ele. Researc
100 Xian Lie Road Central
Guangzhou
Phone: +86-20-776-9464
Fax: +86-20-776-9464

Colombia

Sistemas E Instrumentacion, Ltda.
Calle 83, No. 37-07 Barrio Patria
Ap. Aereo 29583 Bogota
Phone: +57-1-635-7266
Fax: +57-1-623-3334

Costa Rica

Electronic Engineering, S.A.
Carretera De Circunvalacion
Sabanilla Av. Novena
P.O. Box 4300-1000
San Jose
Phone: +506-*253-3759
Fax: +506-*225-1286

Countries not listed

For Eastern Europe And Middle
East
Export Sales
Science Park Eindhoven 5110
5692 EC Son
The Netherlands
Phone: +31-402-678 265
Fax: +31-402-678 260

Croatia

Kaltim - Zagreb
Fluke Sales & Service
Draga 8
41425 Sveta Jana
Phone: +385-41-837115
Fax: +385-41-837237

Cyprus

D. Ouzounian, M. Soutanian & Co.
P.O. Box 1775
Nicosia
Phone: +357-2-442220
Fax: +357-2-459885

Czech Republic

Eiso
NA. Berance 2
16000 Prague 6
Phone: +42-2-316-4810
Fax: +42-2-364-986

SERVICE CENTERS

Czech Republic

Elsco
Branch Office
Optatova 17a
63700 Brno
Phone: +42-5-41220263
Fax: +42-5-524742

Denmark

Fluke Danmark A/S
Ejby Industrivej 40
DK 2600 Glostrup
Phone: +45-43-44-1900
Fax: +45-43-43-9192

Ecuador

Protenco Coasin Cia., Ltda.
Av. 12 de Octubre 2449 y
Orellana
P.O. Box 17-03-228-A
Quito
Phone: +593-2-230283
Fax: +593-2-561980

Egypt

EEMCO
Nasr City
19 Sharah Bldgs.
Hassan Mamoun Street
Cairo
Phone: +20-2-2718873
Fax: +20-2-2718873

Finland

Fluke Finland Oy
Sinikalliontie 5
P.L. 151
SF 02631 Espoo
Phone: +358-0-61525-620
Fax: +358-0-61525-630

France

Fluke France S.A.
37, rue Voltaire
B.P. 112
93700 Drancy
Phone: +33-1-4896-6310
Fax: +33-1-4896-6330

Germany

Fluke Deutschland GmbH
Oskar Messter Straße 18
85737 Ismaning
Münich
Phone: +49-89-99611-260
Fax: +49-89-99611-270

Germany

Fluke Deutschland GmbH
Meiendorfer Straße 205
22145 Hamburg
Phone: +49-40-67 960 434
Fax: +49-40-67 960 421

Greece

George D. Zis & SIA O.E.
Fluke Sales & Service
Zacharitsa 27
117 41 Athens
Phone: +30-1-922 1581
Fax: +30-1-924 9087

Hong Kong

Schmidt & Co., Ltd.
1st Floor
323 Jaffe Road
Wanchai
Phone: +852-2223-5623
Fax: +852-2834-1848

Hungary

Mta-Mmsz Kft.
Etele Ut. 59 - 61
P.O. Box 58
H 1502 Budapest
Phone: +361-203-4319
Fax: +361-203-4328

Hungary

MTA-MMSZ Kft.
Etele Ut. 59 - 61
P.O. Box 58
H 1502 Budapest
Phone: +361-203-4298
Fax: +361-203-4353

Iceland

Taeknival Hf
P.O. Box 8294
Skeifunni 17
128 Reykjavik
Phone: +354-550-4000
Fax: +354-550-4001

India

Hinditron Services Pvt., Ltd.
204-206 Hemkunt Tower
98 Nehru Place
New Delhi 110 019
Phone: +91-11-641-3675
Fax: +91-11-642-9118

India

Hinditron Services Pvt., Ltd.
Castle House, 5th Floor
5/1 A, Hungerford Street
Calcutta 700 017
Phone: +91-33-247-9094
Fax: +91-33-247-6844

India

Hinditron Services Pvt., Ltd.
Emerald House, 5th Floor
114 Sarojini Devi Road
Secunderabad 500 003
Phone: +91-40-844033
Fax: +91-40-847585

India

Hinditron Services Pvt., Ltd.
Hinditron House, 23-B
Mahal Industrial Estate
Mahakali Caves Road,
Andheri East
Mumbai 400 093
Phone: +91-22-836-4560
Fax: +91-22-836-4682

India

Hinditron Services Pvt., Inc.
33/44A 8th Main Road
Raj Mahal Vilas Extension
Bangalore 560 080
Phone: +91-80-334-8266
Fax: +91-80-334-5022

Indonesia

P.T. Daeng Brothers
Philips House
J/n H.R. Rasuna Said Kav. 3-4
Jakarta 12950
Phone: +62-21-520-1122
Fax: +62-21-520-5189

Israel

R.D.T Equipment & Systems
(1993) Ltd.
P.O. Box 58072
Tel Aviv 61580
Phone: +972-3-645-0745
Fax: +972-3-647-8908

Italy

Fluke Italia S.R.L.
Viale Delle Industrie, 11
20090 Vimodrone (MI)
Phone: +39-2-268-434-203
Fax: +39-2-250-1645

SERVICE CENTERS

Japan

Fluke Corporation Japan
Sumitomo Higashi Shinbashi
Bldg.
1-1-11 Hamamatsucho
Minato-ku, Tokyo 105
Phone: +81-3-3434-0181
Fax: +81-3-3434-0170

Jordan

Jordan Medical Supplies and
Services
P.O. Box 140415
Amman 11814
Phone: +962-6-699353
Fax: +962-6-663556

Korea

Fluke Korea Co., Ltd.
5th Floor, Juan Bldg
646-14, Yuksam-Dong
Kangnam-Ku
Seoul 135-080
Phone: +82-2-539-6311
Fax: +82-2-539-6311

Kuwait

Yusuf A. Alghanim & Sons
W.L.L.
P.O. Box 223 Safat
Alghanim Industries
Airport Road Shuwaikh
13003 Kuwait
Phone: +965-4842988
Fax: +965-4847244

Lebanon

DC Electronics S.A.R.L.
Autostrada Dora
Hayek Building
P.O. Box 90
1388 Beirut
Phone: +961-1-884271
Fax: +961-1-898842

Macedonia

Tehnokom
Koco Racin 42
91000 Skopje
Phone: +389-91-236817
Fax: +389-91-236851

Malaysia

Cnn Sdn. Bhd.
17D, 2nd Floor
Lebuhraya Batu Lancang
Taman Seri Damai
11600 Jelutong Penang
Phone: +60-4-657-9584
Fax: +60-4-657-0835

Malta

Cam Services Ltd.
Cam Centre
Triq 1 - Industrija
Qormi QRM 09
Phone: +356-484640
Fax: +356-447174

Mexico

Metrologia Y Calibraciones Ind.,
S.A. De C.V.
Industrial S.A. De C.V.
Calle Diagonal No. 27 - 4 Piso
Colonia Del Valle
Mexico 03100 D.F.
Phone: +52-5-682-8040
Fax: +52-5-687-8695

Netherlands

Fluke Nederland B.V.
Customer Support Services
Science Park Eindhoven 5108
5692 EC Son
Phone: +31-402-678 310
Fax: +31-402-678 321

New Zealand

Philips Scientific & Industrial,
Pty., Ltd.
Private Bag 41904
St. Lukes, 2 Wagener Place
Mt. Albert
Auckland 3
Phone: +64-9-849-4160
Fax: +64-9-849-7814

Norway

Fluke Norge A/S
Customer Support Services
P.O. Box 6054
Etterstad
N 0601 Oslo
Phone: +47-22-65-3400
Fax: +47-22-65-3407

Pakistan

Philips Electrical Industries Of
Pakistan Ltd.
Islamic Chamber of Commerce
St-2/A, Block 9
KDA Scheme 5, Clifton
Karachi 75600
Phone: +92-21-587-4641
Fax: +92-21-577-0348

Peru

Importaciones &
Representaciones
Jr. Pumacahua 955
Lima 11
Phone: +51-14-235099
Fax: +51-14-310707

Philippines

Spark Electronics Corporation
P.O. Box 610, Greenhills
Metro Manila 1502
Phone: +63-2-700621
Fax: +63-2-721-0491

Poland

Electronic Instrument Service
(E.I.S.)
UL. Malechowska 6
60 188 Poznan
Phone: +48-61-681998
Fax: +48-61-682256

Portugal

ARESAGANTE
Representacoes Estudos e
Servicos, Lda.
Rua Oliveira Gaio, 333 R/C, Esq.
4465 S.Mamede Infesta
Phone: +351-2-906.00.22
Fax: +351-2-901.68.72

Qatar

Darwish Trading Co.
P.O. Box 92
Doha
Phone: +974-422781
Fax: +974-417599

Rep. of Belarus

Component & Systems Ltd.
7, Melnikaite Str.
220004 Minsk
Phone: +375-172-292103
Fax: +375-172-292110

Romania

RONEXPRIM S.R.L.
Str. Transilvaniei Nr. 24
70778 Bucharest - I
Phone: +40-1-6143597
Fax: +40-1-6594468

Russia

Swemel Innovation Enterprise
15, 4-Th Likhachevskiy Lane
125438 Moscow
Phone: +7-095-154-5181
Fax: +7-095-154-0201

SERVICE CENTERS

Russia C.I.S.

Infomedia
Petrovsko Razumovsky
Proezd. 29
103287 Moscow
Phone: +7-095-2123833
Fax: +7-095-2123838

Saudi Arabia

A. Rajab & Silsilah Co.
Sales & Service Department
P.O. Box 203
21411 Jeddah
Phone: +966-2-6610006
Fax: +966-2-6610558

Singapore

Fluke Singapore Pte., Ltd.
#27-03 PSA Building
460 Alexandra Road
Singapore 119963
Phone: +65*-276-5161
Fax: +65*-276-5929

Slovak Republic

Elso
Stef nikova 20
911 01 Trencin
Phone: +42-8313-1410
Fax: +42-8313-1592

Slovenia

Micom Electronics d.o.o.
Resljeva 34
61000 Ljubljana
Phone: +386-61-317830
Fax: +386-61-320670

Slovenia

Elacss d.o.o.
Medvedova 28
61000 Ljubljana
Phone: +385-61-317178
Fax: +385-61-301595

South Africa

Spescom Measuregraph Pty., Ltd.
SPESCOM Park
Crn. Alexandra Rd. & Second St.
Halfway House
Midrand 1685
Phone: +27-11-315-0757
Fax: +27-11-805-1192

Spain

Fluke Ib,rica S.L.
Centro Empresarial Euronova
C/Ronda De Poniente, 8
28760 - Tres Cantos
Madrid
Phone: +34-1-804-2301
Fax: +34-1-804-2496

Sultanate Of Oman

Mustafa & Jawad Science &
Industry Co. LLC.
P.O. Box 1918
112 Ruwi - Muscat
Phone: +968-602009
Fax: +968-607066

Sweden

Fluke Sverige AB
P.O. Box 61
S 164 94 Kista
Phone: +46-8-751-0235
Fax: +46-8-751-0480

Switzerland

Fluke Switzerland A.G.
Rütistrasse 28
CH 8952 Schlieren
Phone: +41-1-730-3310
Fax: +41-1-730-3720

Taiwan, R.O.C.

Schmidt Scientific Taiwan, Ltd.
6f, No. 109, Tung Hsing St.
Taipei
Phone: +886-2-767-8890
Fax: +886-2-767-8820

Thailand

Measuretronix Ltd.
2102/31 Ramkamhang Road
Bangkok 10240
Phone: +66-2-375-2733
Fax: +66-2-374-9965

Turkey

Pestas Prof. Elektr. Sistemler
Tic. ve San. A.S.
Meydan Sokak
Meydan Apt. No. 6/23
Akatlar 80630
Istanbul
Phone: +90-212-2827839
Fax: +90-212-283-0987

U.A.E.

Haris Al-Afaq Ltd.
P.O. Box 8141
Dubai
Phone: +971-4-283623
Fax: +971-4-281285

U.S.A.

Fluke Corporation
Service Center - Palatine
1150 W. Euclid Avenue
Palatine, IL 60067
Phone: +1-847-705-0500
Fax: +1-847-705-9989

U.S.A.

Fluke Corporation
Service Center - Paramus
West 75 Century Road
Paramus, NJ 07652-0930

U.S.A.

Fluke Corporation
Service Center - Everett
P.O. Box 9090
Everett, WA 98206-9090
Phone: +1-206-356-5531
Fax: +1 206 356 6390

U.S.A.

Fluke Calibration Center
C/o Flw Service Corporation
3505 Cadillac Ave., Bldg E.
Costa Mesa, Ca 92626
Phone: +1-714-863-9031
Fax: +1-714-751-0213

U.S.A.

Fluke Corporation
Service Center
42711 Lawrence Place
Fremont, CA 94538
Phone: +1-510-651-5112
Fax: +1-510-651-4962

U.S.A.

Fluke Corporation
Service Center - Dallas
2104 Hutton Drive
Suite 112
Carrollton, TX 75006
Phone: +1-214-406-1000
Fax: +1-214-247-5642

SERVICE CENTERS

United Kingdom

Fluke United Kingdom Ltd.
Colonial Way
Watford
Hertfordshire WD2 4TT
Phone: +44-1923-240511
Fax: +44-1923-212157

Uruguay

Coasin Instrumentos S.A.
Acevedo Diaz 1161
11200 Montevideo
Montevideo
Phone: +598-2-492-436
Fax: +598-2-492-199

Venezuela

Coasin C.A.
Calle 9 Con Calle 4
Edif Edinurbi Piso - 3
La Urbina
Caracas 1070-A
Phone: +58-2-242-7466
Fax: +58-2-241-1939

Vietnam

Schmidt-Vietnam Co., Ltd.
8/f. Schmidt Tower
Hanoi International Technology
Ctr
Km8, Highway 32, Cau Giay
Tu Liem, Hanoi
Phone: +84-4-8346-186
Fax: +84-4-8346-188

All other countries

Fluke Corporation
P.O. Box 9090
Mail Stop 268C
Everett, WA 98206-9090
USA

SERVICE CENTERS

To locate an authorized service center, visit us on the World Wide Web:

<http://www.fluke.com>

or call Fluke using any of the phone numbers listed below:

+1-888-993-5853 in U.S.A. and Canada

+31-402-678-200 in Europe

+1-425-356-5500 from other countries

SERVICE-ZENTREN

Wenn Sie die Adresse eines autorisierten Fluke-Servicezentrums brauchen,

besuchen Sie uns doch bitte auf dem World Wide Web:

<http://www.fluke.com>

oder rufen Sie uns unter einer der nachstehenden Telefonnummern an:

+1-888-993-5853 in den USA und Canada

+31-402-678-200 in Europa

+1-425-356-5500 von anderen Ländern aus

CENTRES DE SERVICE APRES-VENTE

Pour localiser un centre de service, visitez-nous sur le World Wide Web:

<http://www.fluke.com>

ou téléphonez à Fluke:

+1-888-993-5853 aux U.S.A. et au Canada

+31-402-678-200 en Europe

+1-425-356-5500 pour les autres pays